

	max 90mm	EHN EHV
	max 45mm	EZN EZV EZJ
	max 5mm	ESN ESV ESJ
	380-420mm 12-16mm	EGV
	250-280mm max 18mm	EPV
	max 5mm (V,J) max 15mm (N)	ELN ELV ELJ
		EEN EEV EEJ

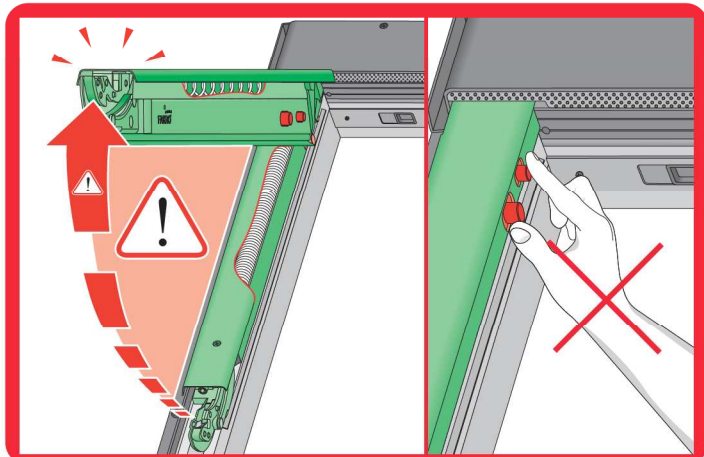

CZ Výrobce a prodejce nenesou žádnou odpovědnost za nedodržení příslušných předpisů zákona, stavebních předpisů a bezpečnostních požadavků při užívání výrobku, architektu, montážní nebo majitele objektu.

DE Hersteller und Verkäufer übernehmen keine Haftung für Nichtbeachtung entsprechender Rechts- und Bauvorschriften sowie Sicherheitsanforderungen seitens Produktbenutzer, Architekten, Monteurs oder Gebäudebesitzer.

ES El fabricante y el vendedor no tienen ninguna responsabilidad por el incumplimiento de la ley vigente, normas de construcción y exigencias de seguridad por parte del usuario del producto, arquitecto, instalador o el propietario del edificio.

FR Le fabricant et le vendeur ne prend aucune responsabilité de ne pas respecter les lois applicables, les règlements sur les bâtiments et les exigences de sécurité par l'utilisateur du produit, l'architecte, l'installateur ou le propriétaire du bâtiment.

GB Manufacturer and Seller shall bear no liability for failure to comply with the applicable laws, building codes and safety requirements by the user of the product, architect, fitter or owner of the building.

HU A gyártó és a forgalmazó nem vállal semmiféle felelősséget a vonatkozó törvényi, építési és biztonsági előírások nemtörődő betartása, építész, beszállítómester vagy épülettulajdonos által be nem tartásáért.

IT Il Produttore e il Rivenditore non potranno essere ritenuti responsabili per il mancato rispetto da parte dell'utente del prodotto, del progettista, dell'installatore o del proprietario dell'edificio, delle leggi vigenti, nonché dei regolamenti edilizi e di quelli relativi alla sicurezza.

NL De fabrikant en verkoper zijn niet aansprakelijk voor gevolgen bij het niet opvolgen van toepasselijke wetten, bouwbesluiten en veiligheidsvoorschriften door de gebruiker van het product, de architect, de installateur of de eigenaar van het gebouw.

PL Producent i Sprzedawca nie ponoszą żadnej odpowiedzialności za nieprzestrzeganie stosownych przepisów prawa, przepisów budowlanych i wymogów bezpieczeństwa przez użytkowników produktu, architektów, monterów lub właścicieli budynków.

PT O fabricante e o vendedor não tem nenhuma responsabilidade pelo o não cumprimento da lei, códigos de construção e as exigências de segurança por parte do usuário do produto, arquiteto, instalador ou proprietário do edifício.

RO Nici producătorul, nici distribuitorul nu își vor asuma niciun fel de răspundere pentru nerespectarea legilor în vigoare, a legilor din domeniul construcțiilor sau a măsurilor de siguranță impuse utilizatorilor produsului, arhitecților, montajistilor sau proprietarilor clădirii.

RU В случае несоблюдения архитектором, монтажником или владельцем здания строительных правил и норм безопасности ответственность с производителя и продавца снимается.

SK Výrobca a predajca nenesú žiadnu zodpovednosť za nedodržanie príslušných ustanovení zákona, stavebných predpisov a bezpečnostných požiadaviek užívateľom výrobku, architektom, montérom alebo majiteľom objektu.



FPP-V, FPU-V, FPW-V

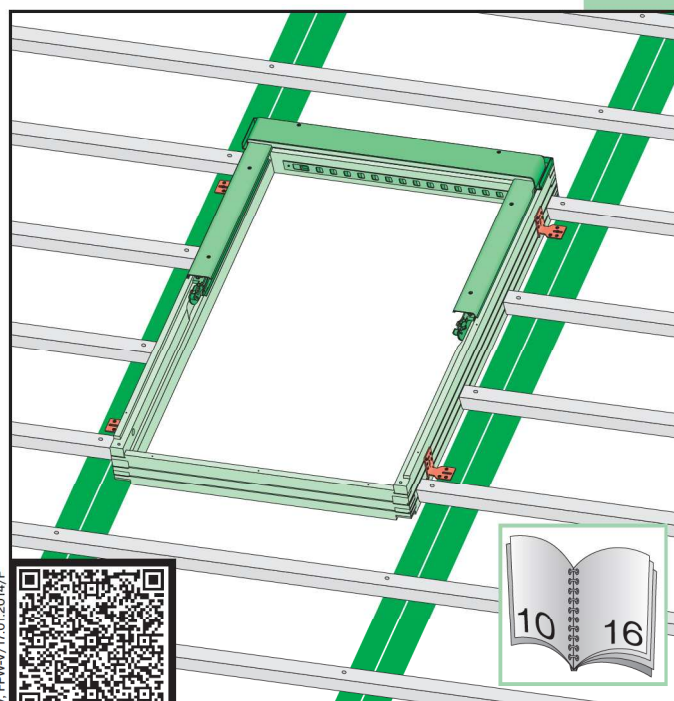
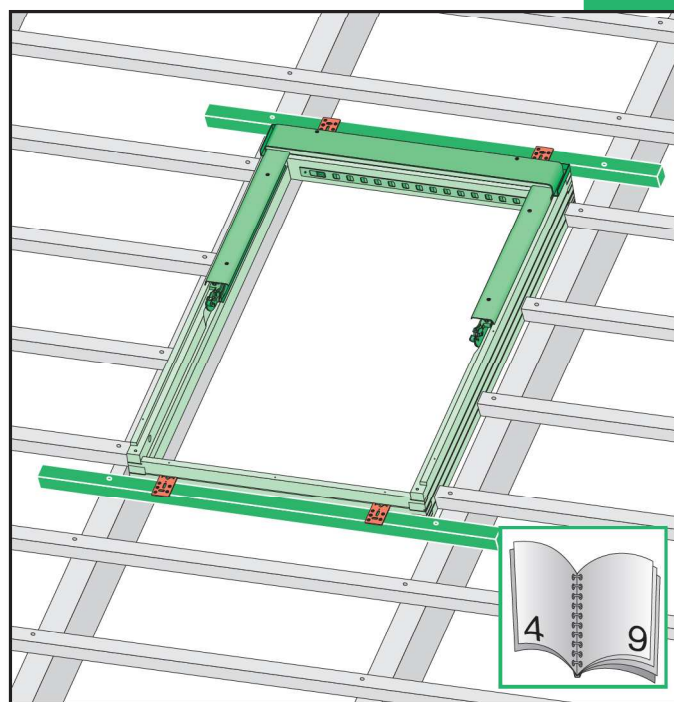

NC 138 IM/FPP-V, FPU-V, FPW-V/17.01.2014/F



<http://www.fakro.com/download/film-installation-instructions/roof-windows/>



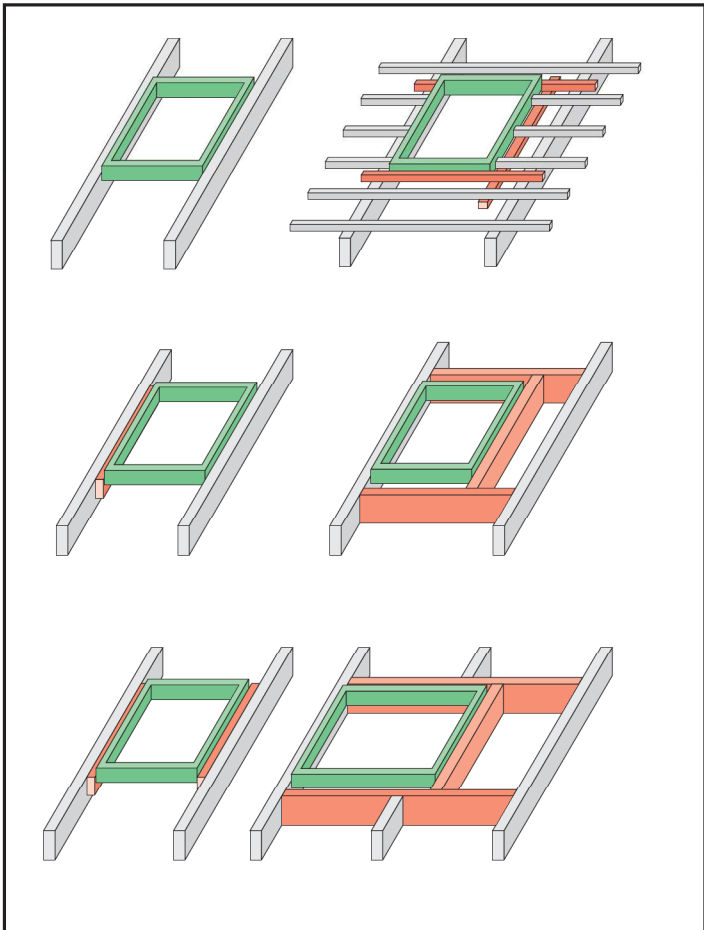
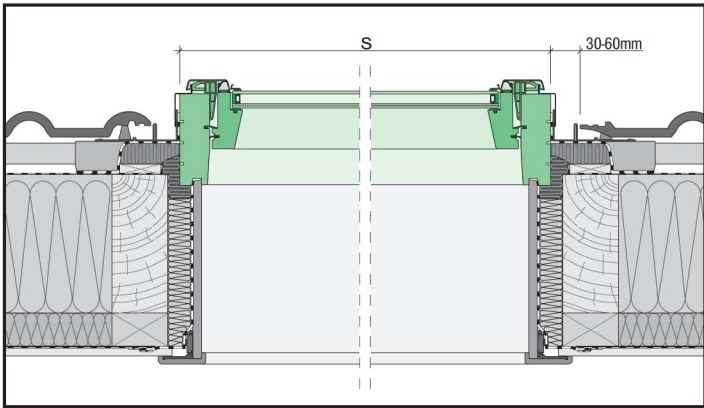
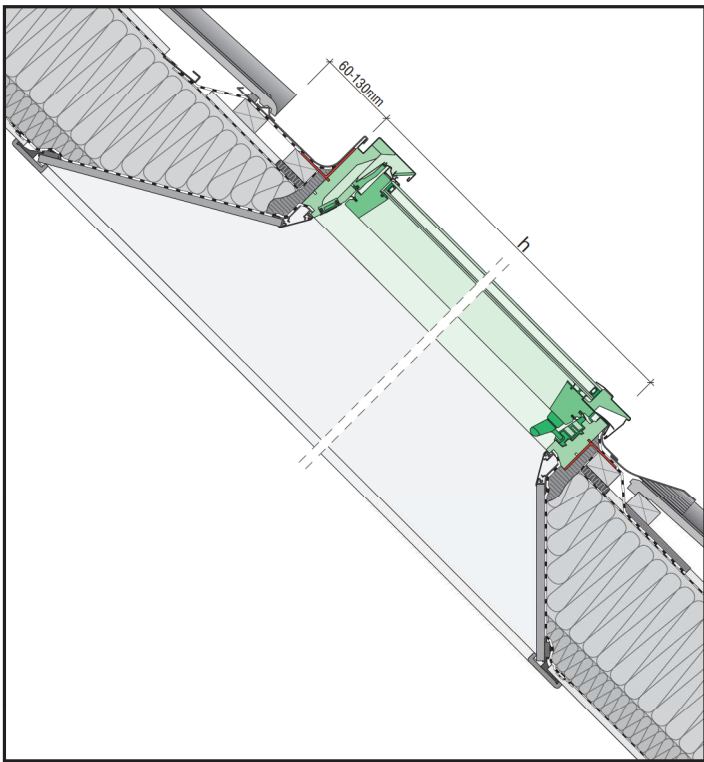



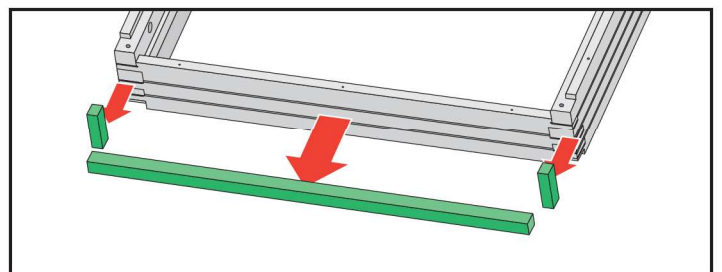
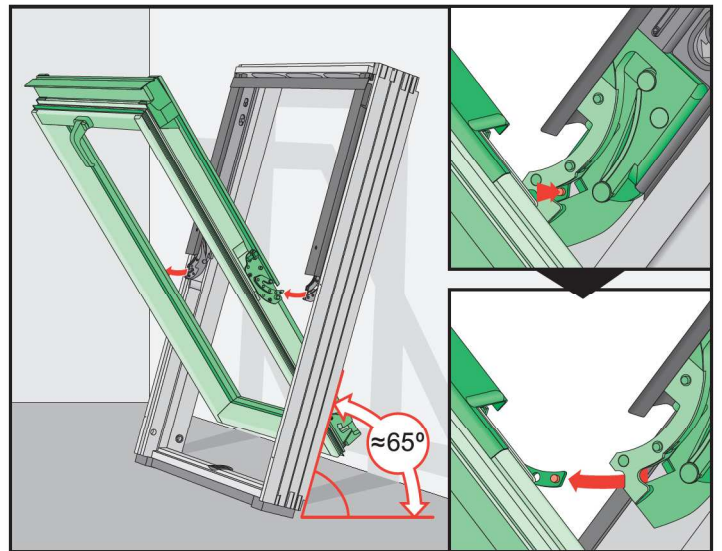
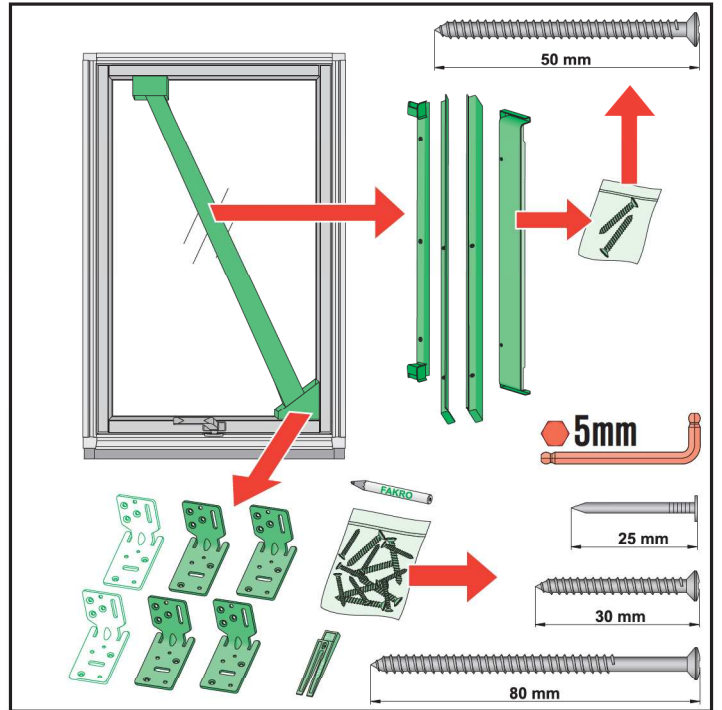
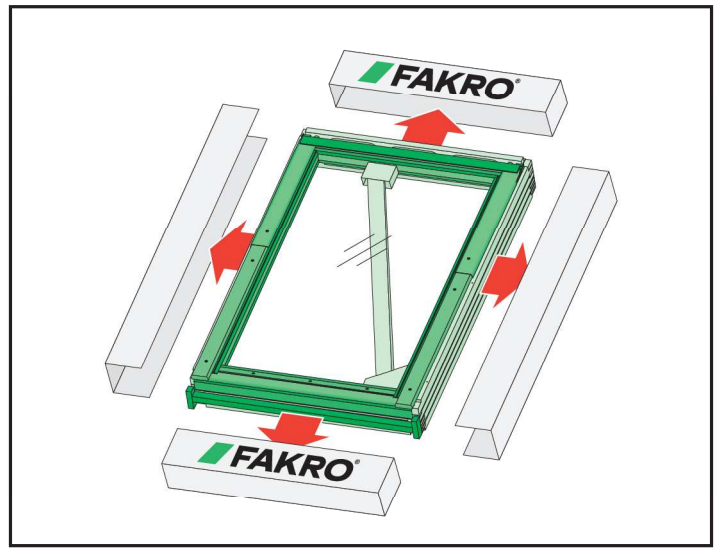



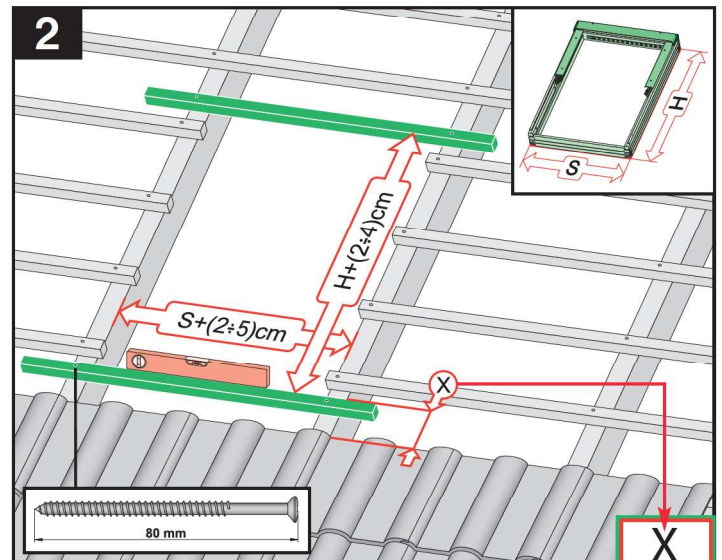
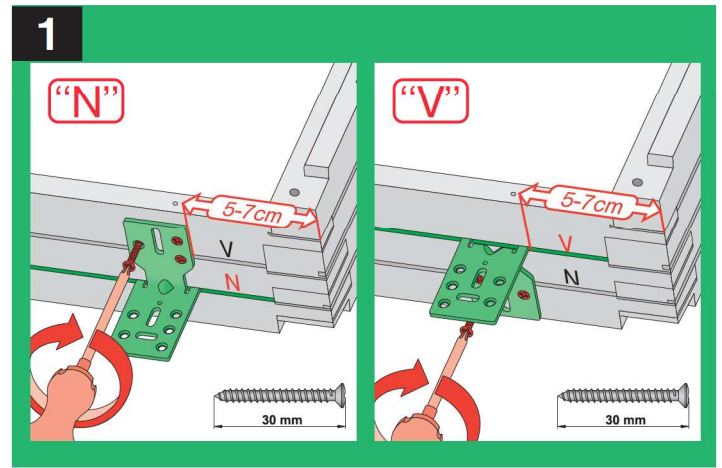
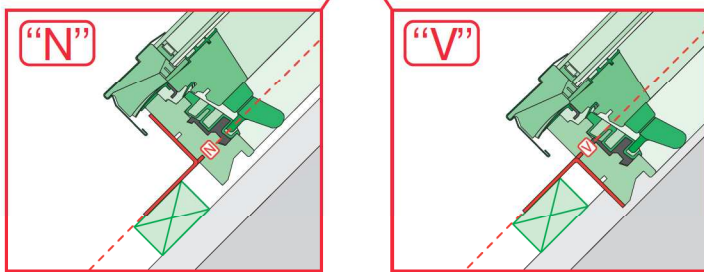
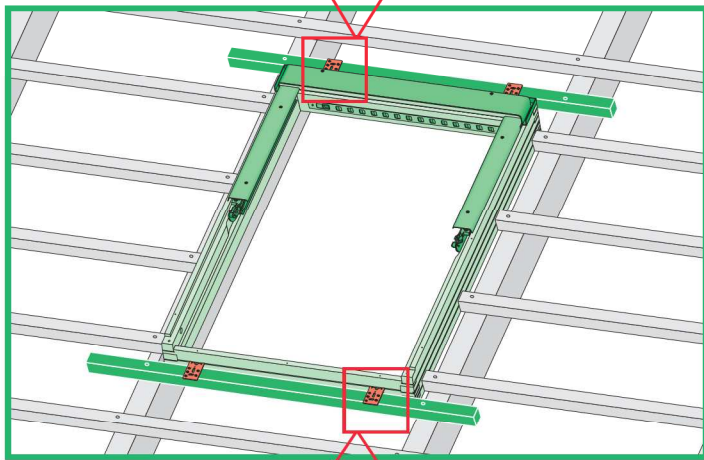
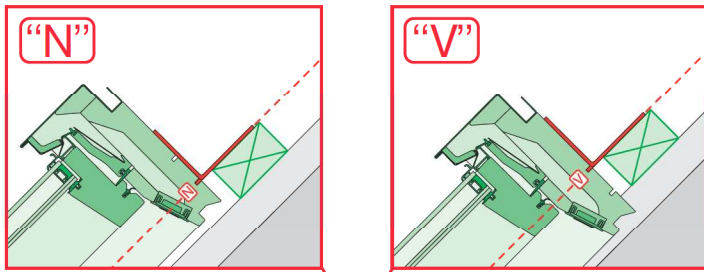















2









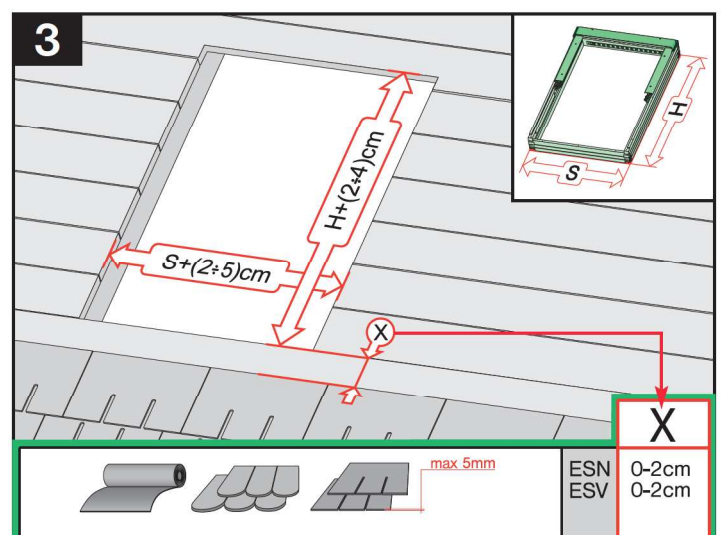



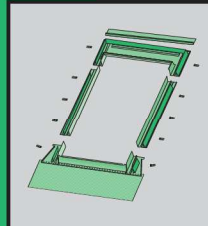





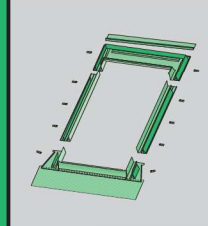





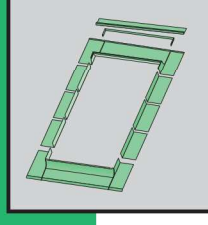

3

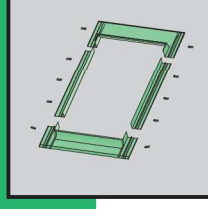

			max 90mm	EHN	7-10cm
			max 45mm	EZN	6-8cm
			max 45mm	EZV	6-8cm
			12-16mm	EGV	6cm
			12-16mm	EPV	6cm
			max 5mm (V) max 15mm (N)	ELN ELV	0-2cm 0-2cm
				EEN EEV	0-2cm 0-2cm



			max 5mm	ESN	0-2cm
				ESV	0-2cm

	max 90mm		EHN		15°-55°
			EHV		15°-55°
			-		-
	max 45mm		EZN		15°-55°
			EZV		15°-55°
			-		-
	max 15mm (N) max 5mm (V)		ELN		15°-55°
			ELV		15°-55°
			-		-
	max 5mm		ESN		15°-55°
			ESV		15°-55°
			-		-

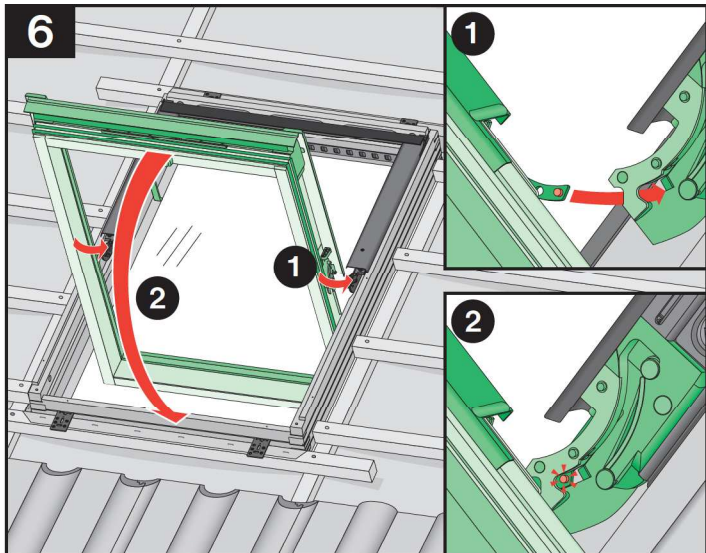
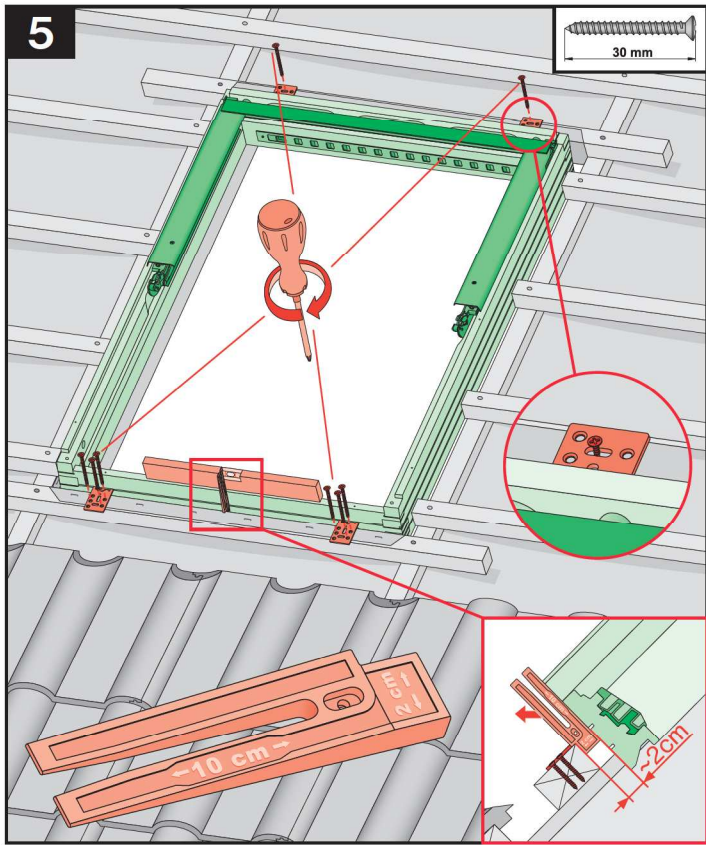
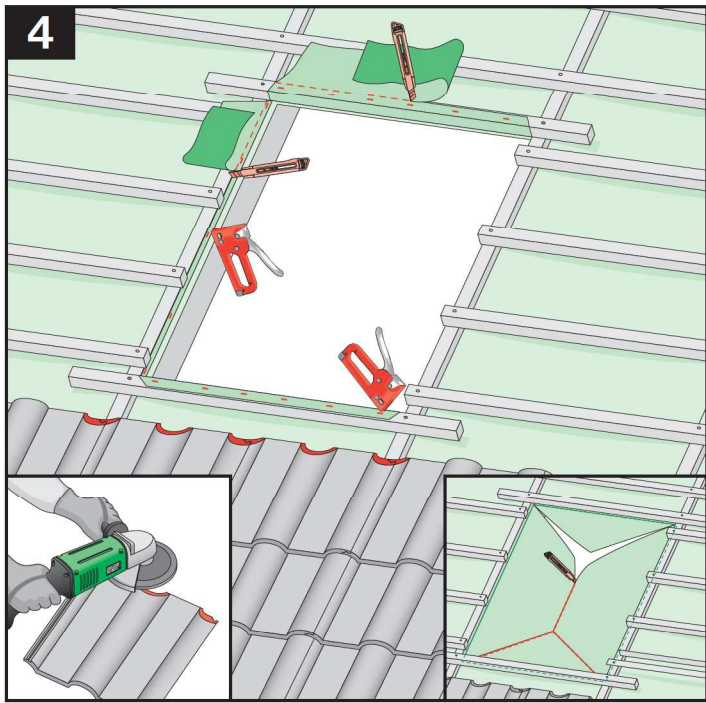

6

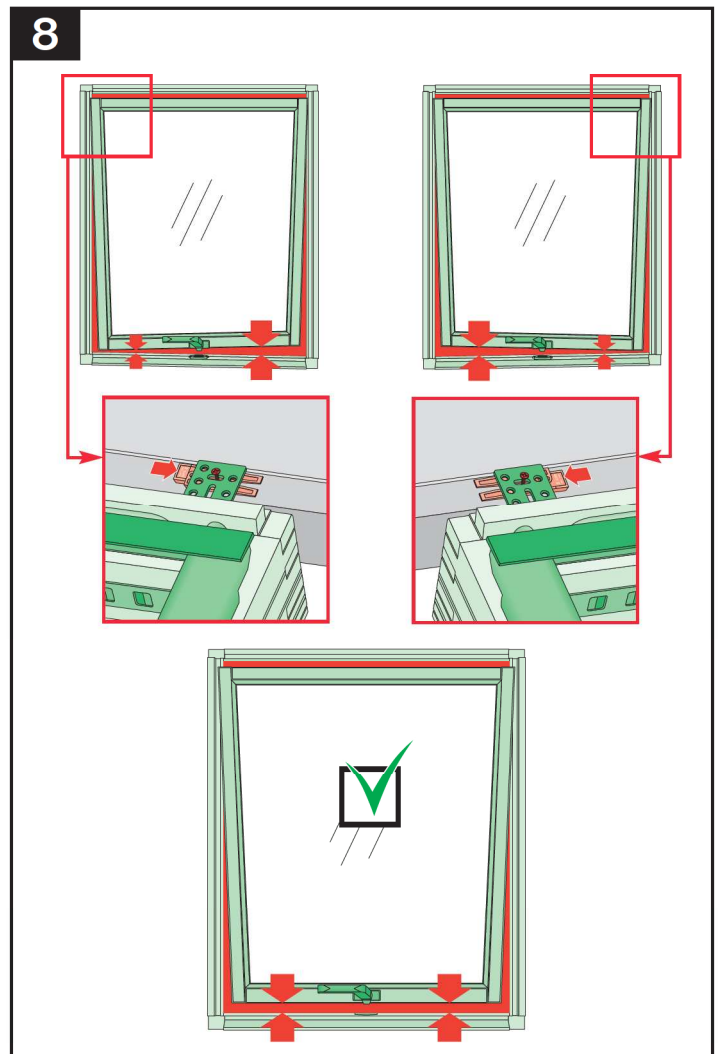
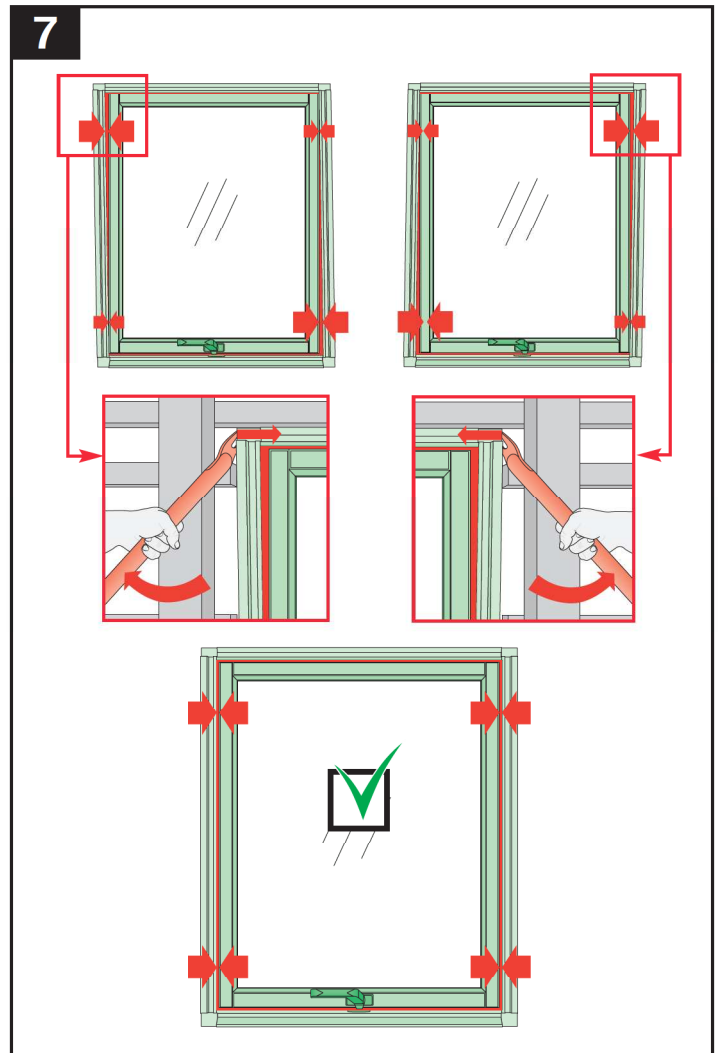

7

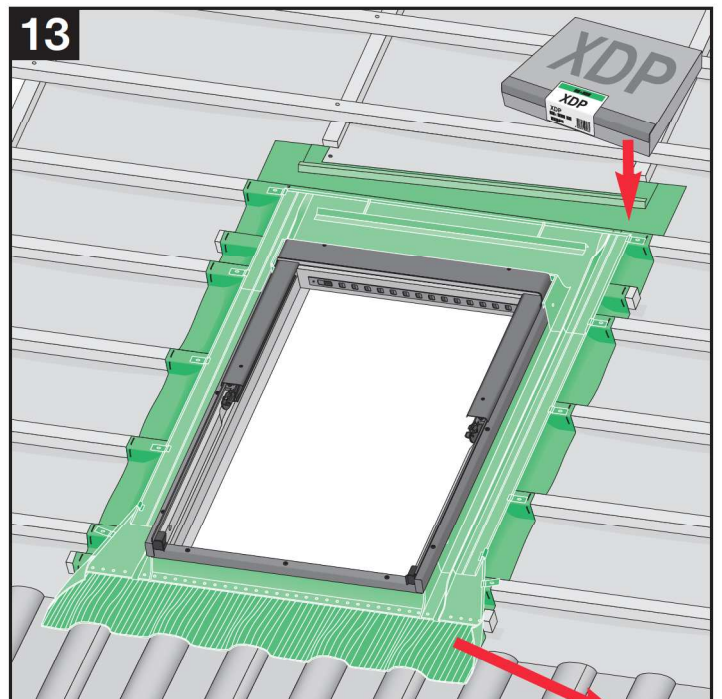
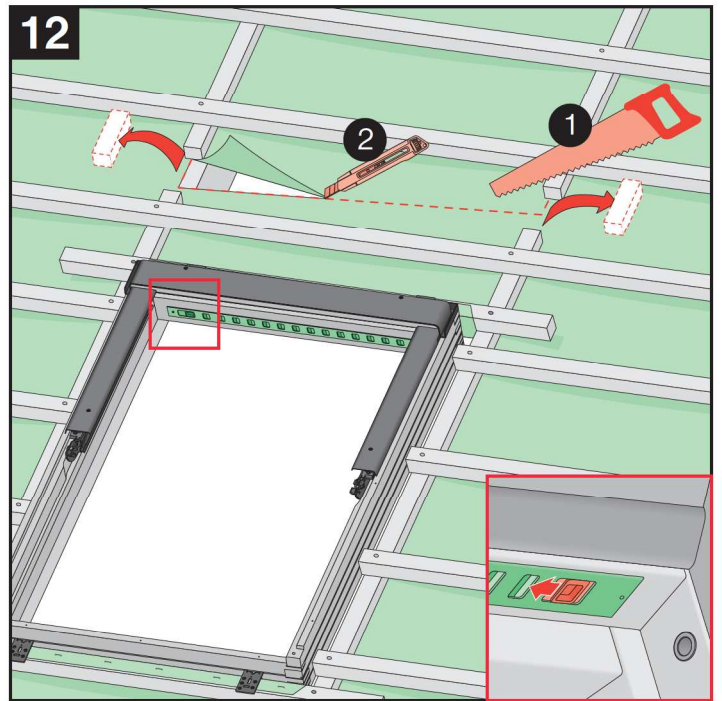
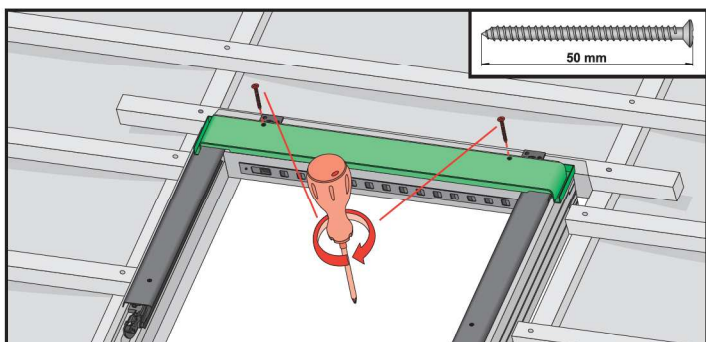
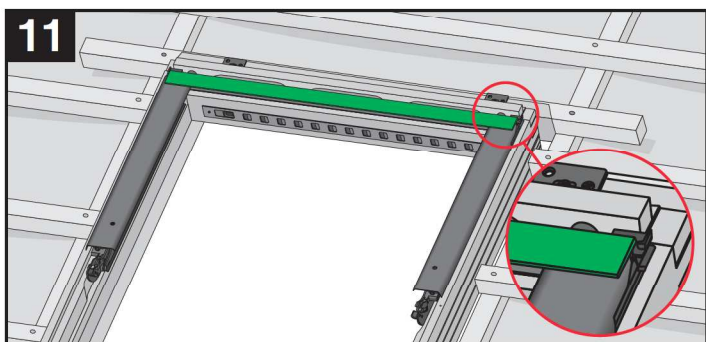
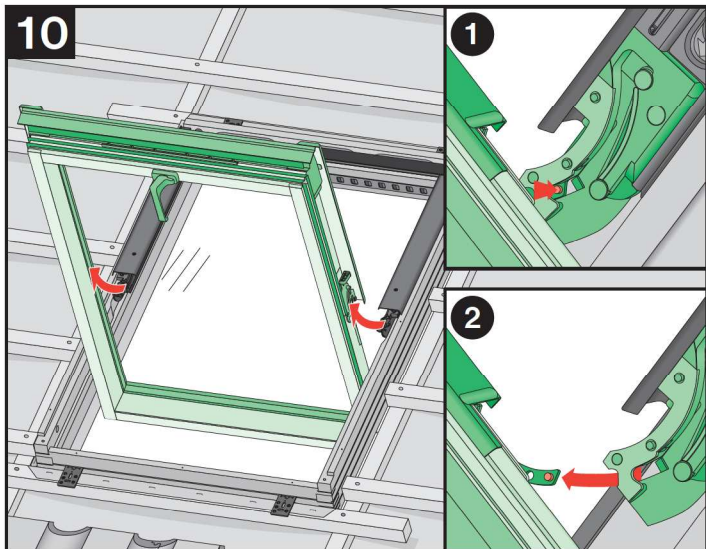
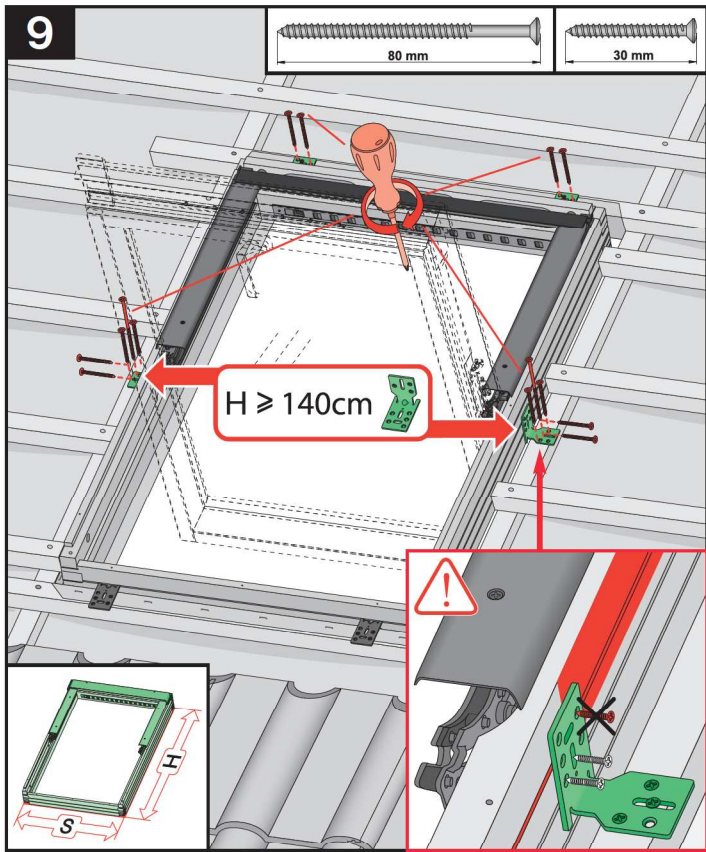

	max 90mm	EHN EHV
	max 45mm	EZN EZV
	max 5mm	ESN ESV
	350-420mm 12-16mm	EGV
	250-280mm max 18mm	EPV
	max 5mm (V) max 15mm (N)	ELN ELV
		EEN EEV

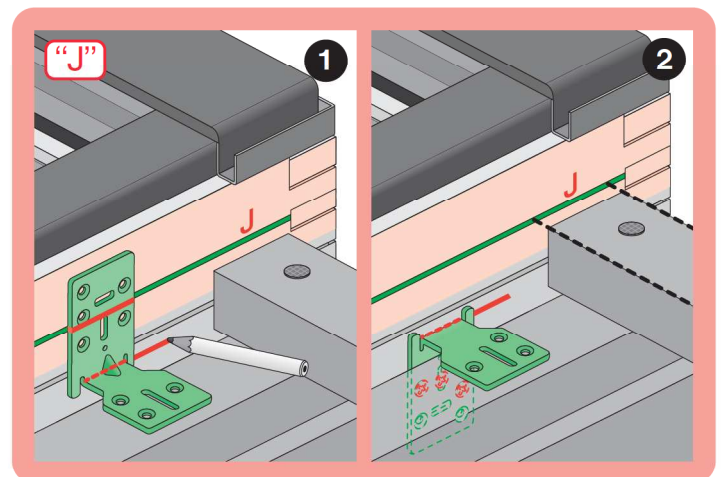
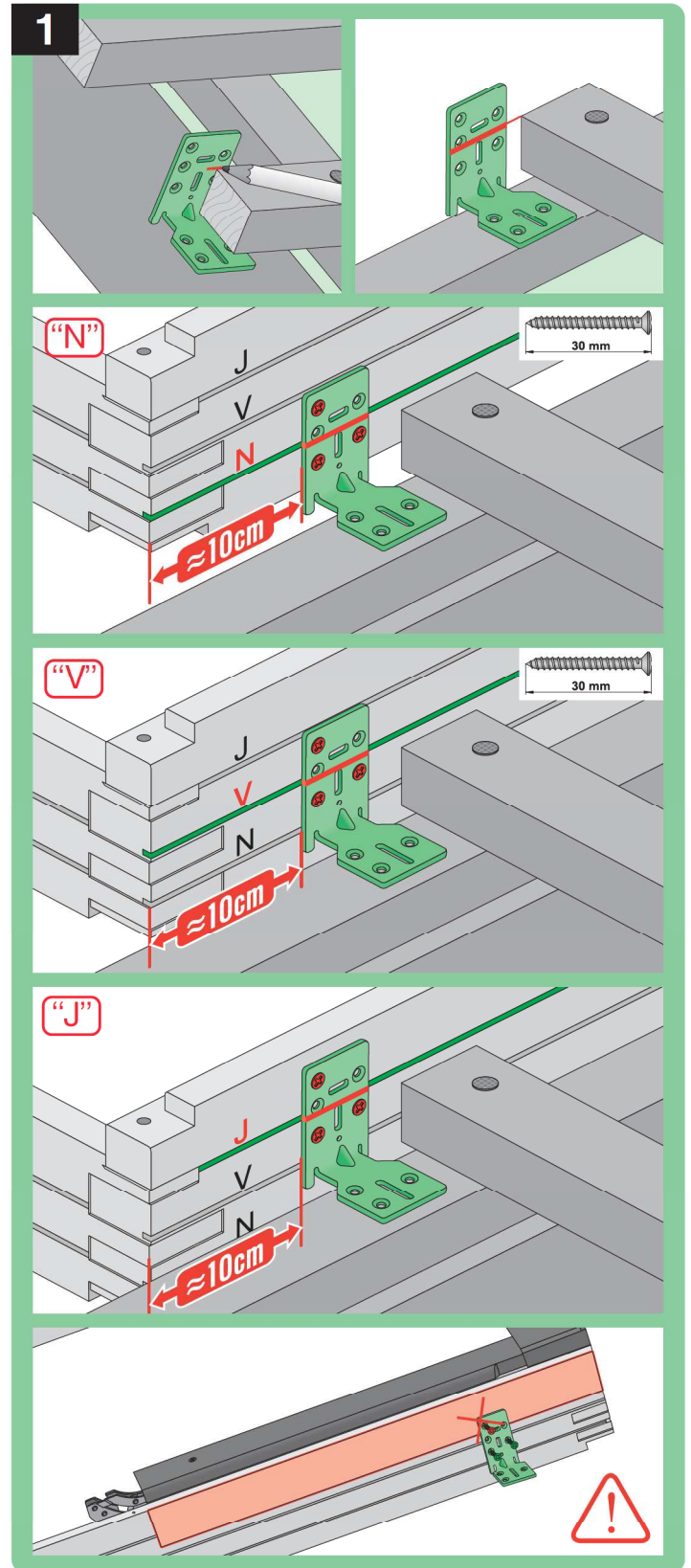
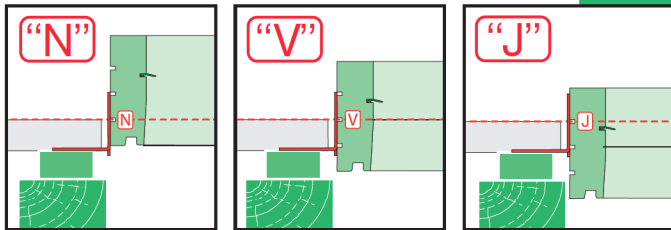
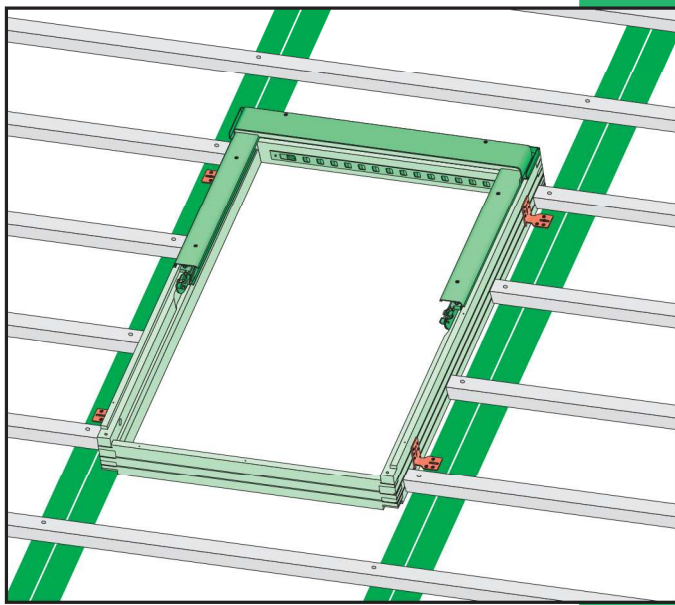

	max 90mm	EHN		
		EHV		
		-	-	-
	max 45mm	EZN		
		EZV		
		EZJ		
	max 15mm (N) max 5mm (V) max 5mm (J)	ELN		
		ELV		
		ELJ		
	max 5mm	ESN		
		ESV		
		ESJ		

2

	max 90mm	EHN	9-12cm
		EHV	9-12cm
	max 49mm	EZN	8-10cm
		EZV	8-10cm
		EZJ	20cm
	12-16mm	EGV	6cm
	max 18mm	EPV	8cm
	max 5mm (V,J) max 15mm (N)	ELN	0-4cm
		ELV	0-4cm
		ELJ	11cm
		EEN	0-4cm
		EEV	0-4cm
		EEJ	11cm

3

	max 5mm	ESN	0-4cm
		ESV	0-4cm
		ESJ	0cm

4

5

6

7

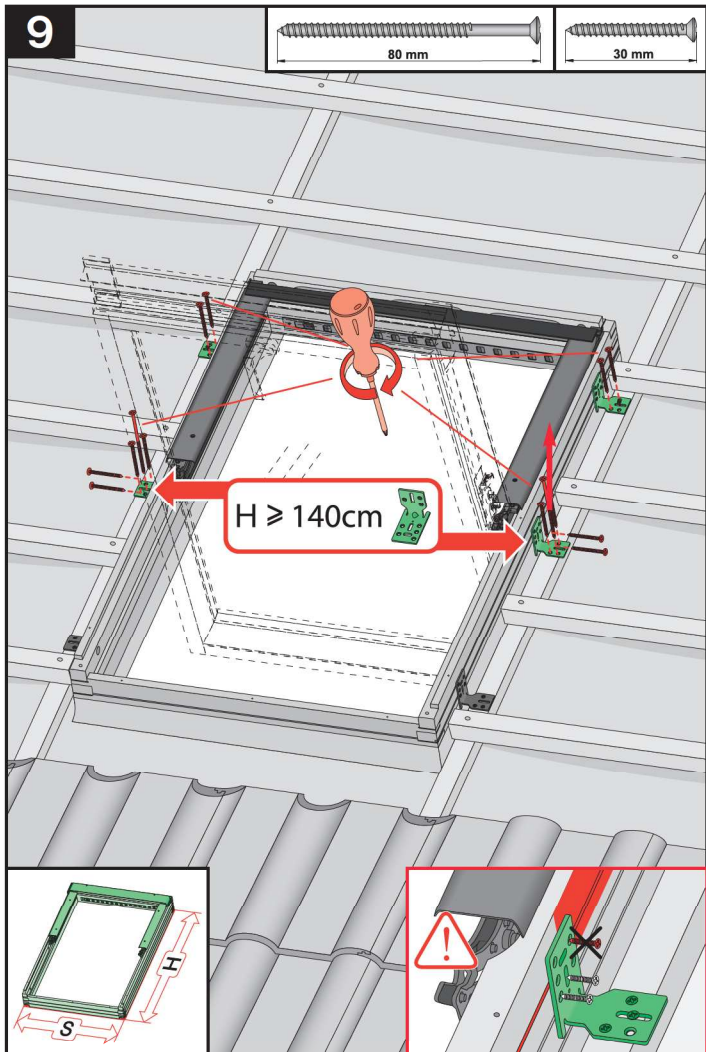
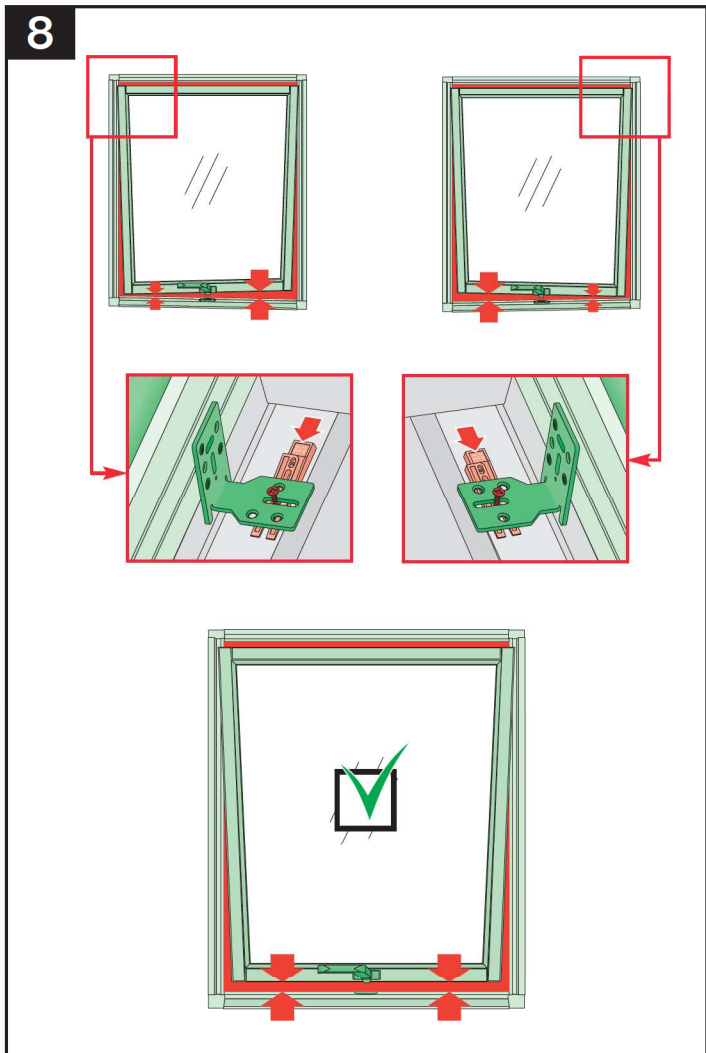

14

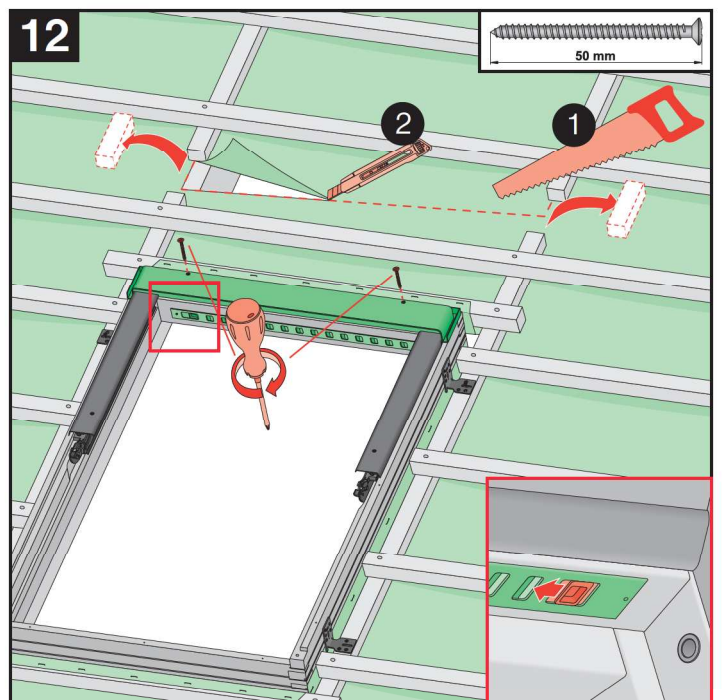
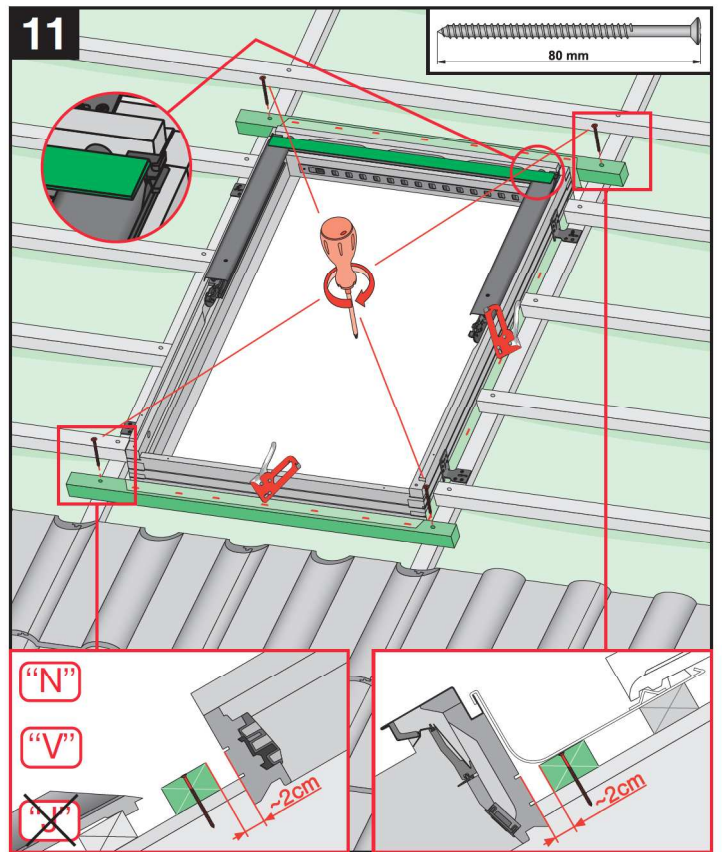
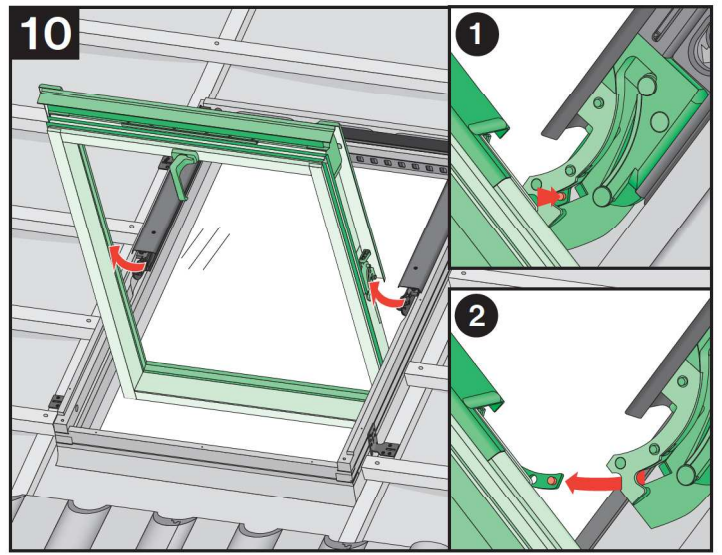

15