

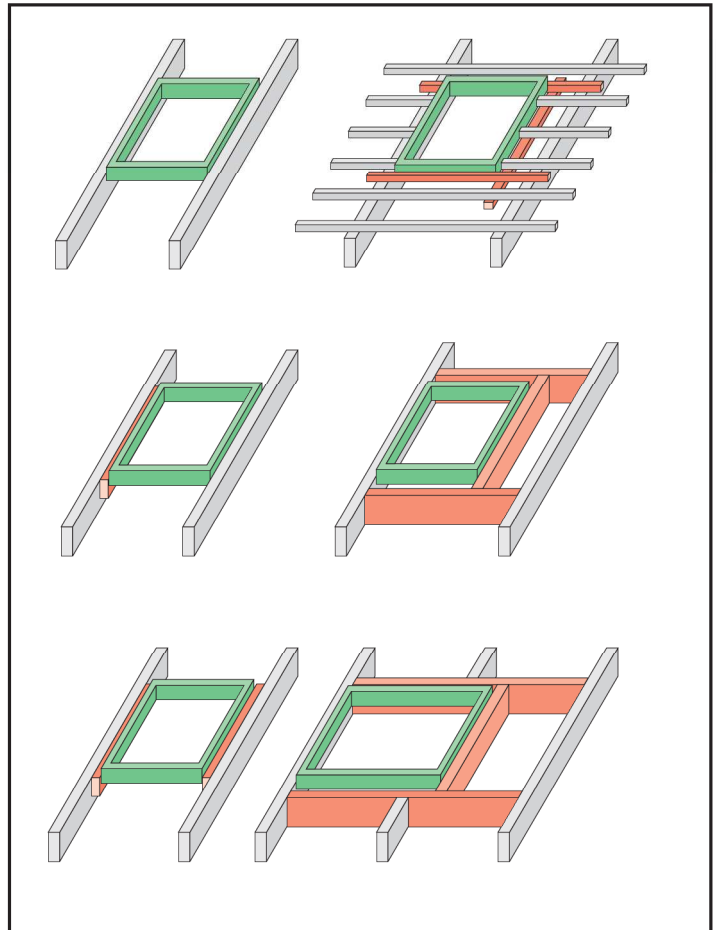

FTP-V Electro Z-Wave
FTU-V Electro Z-Wave

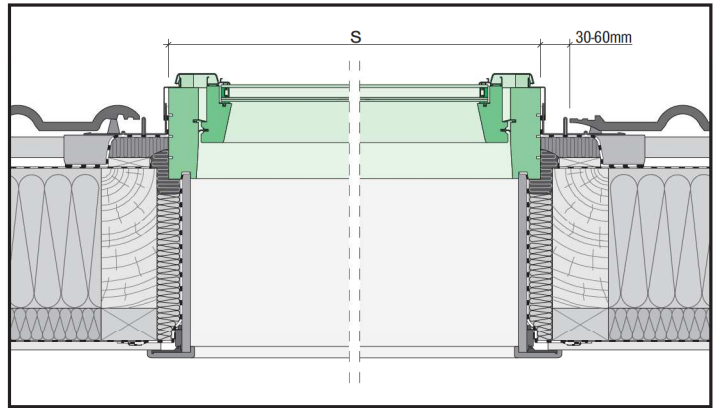

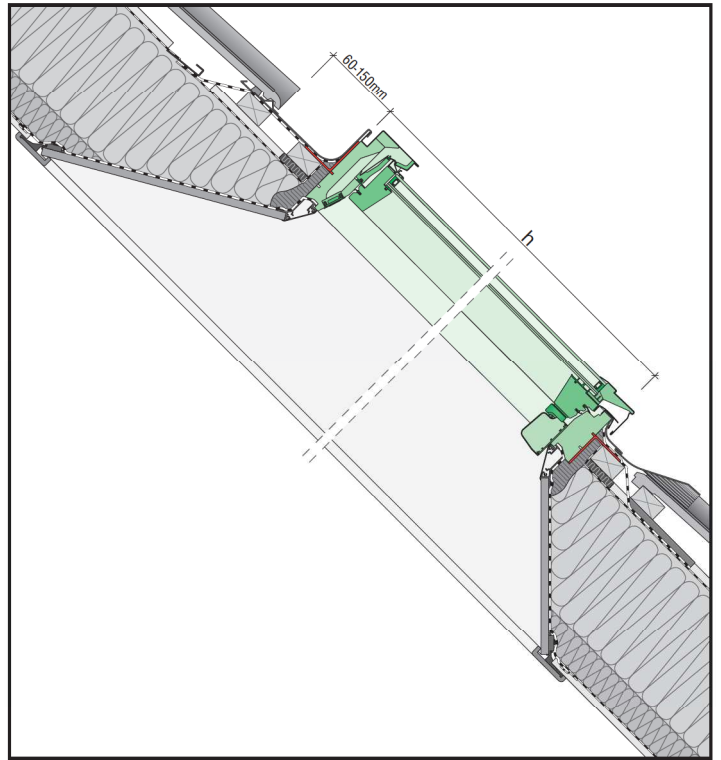

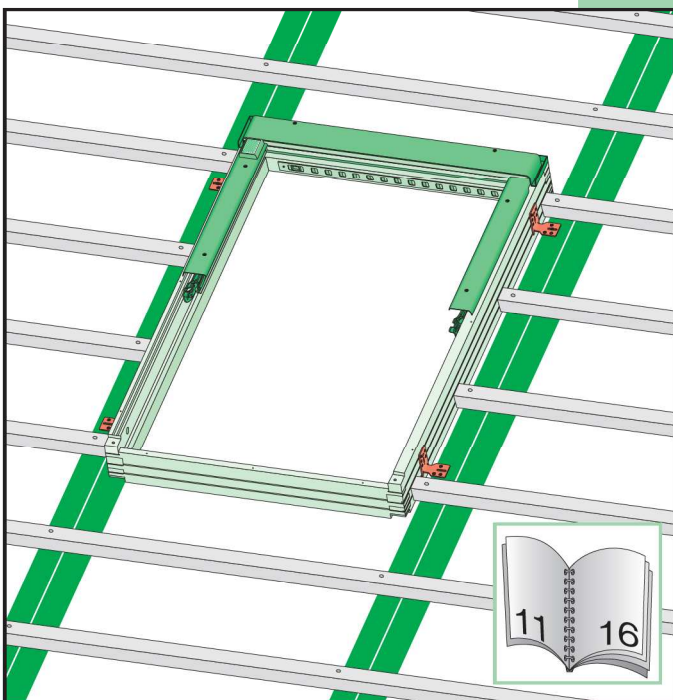
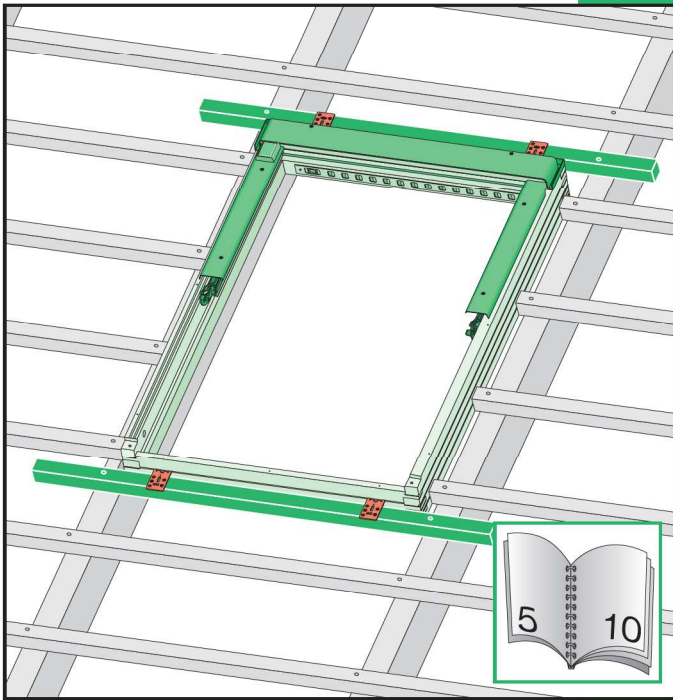
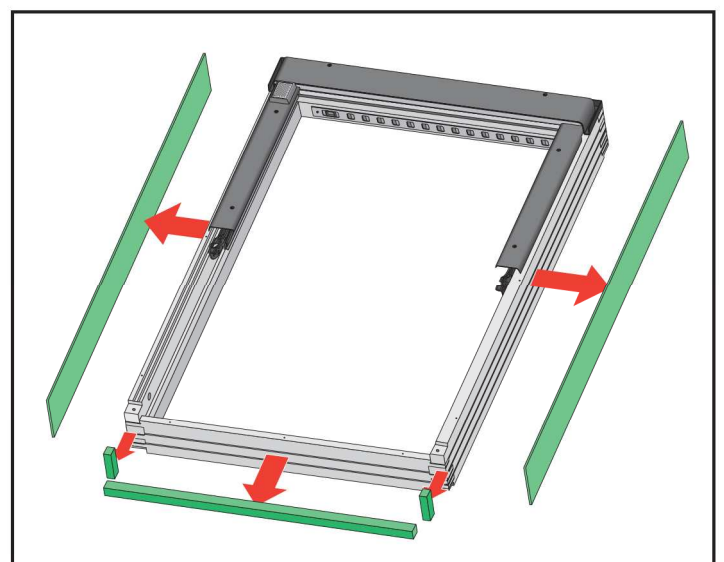
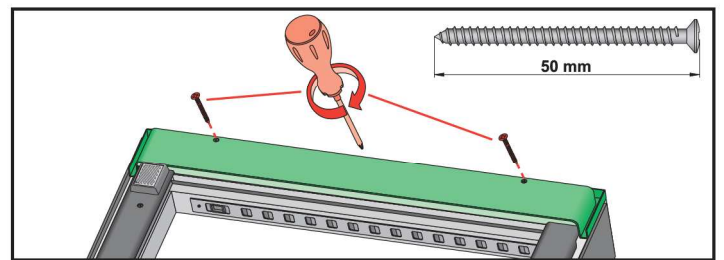
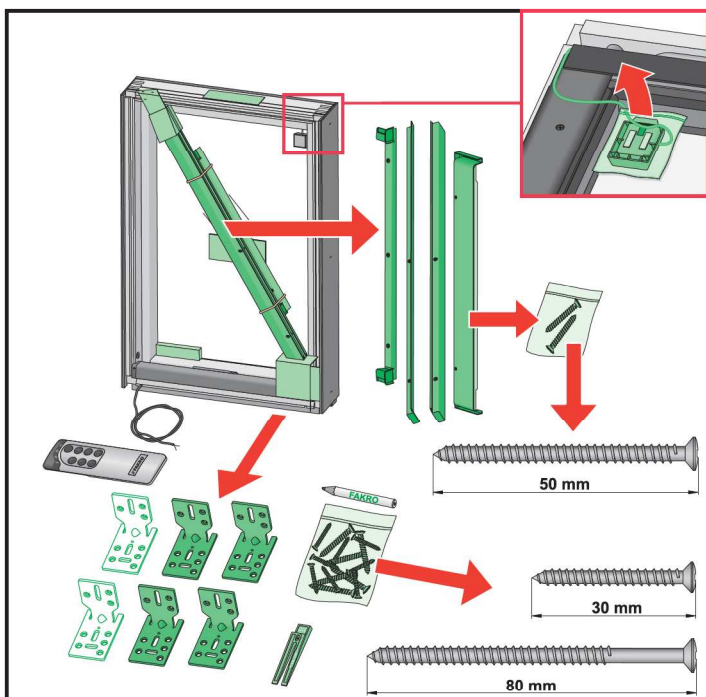
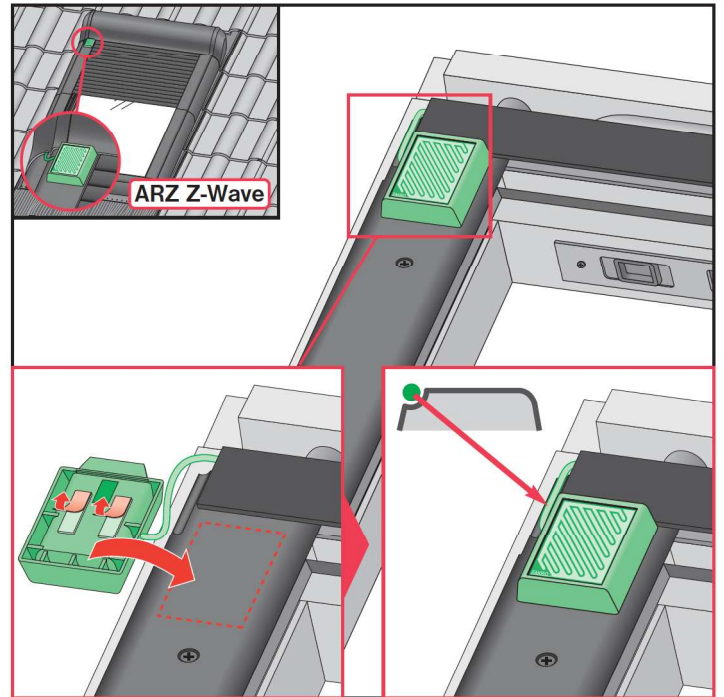
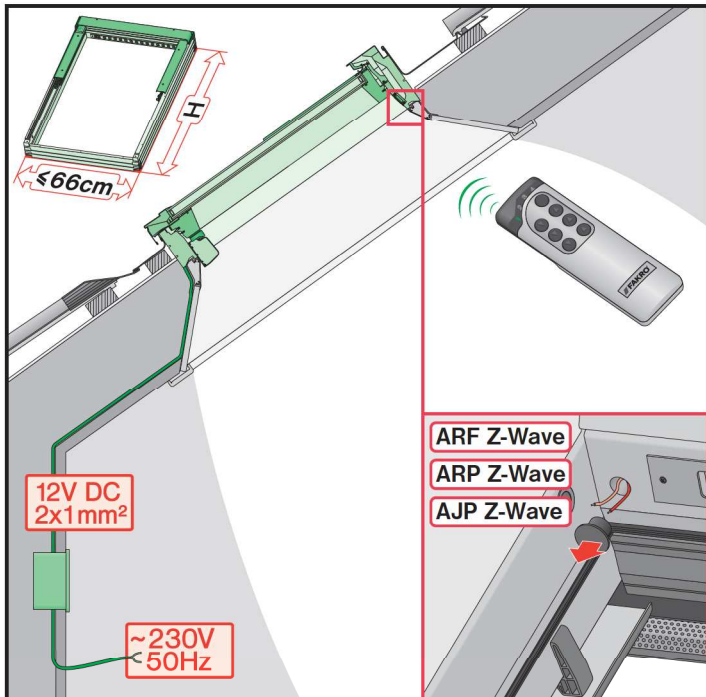
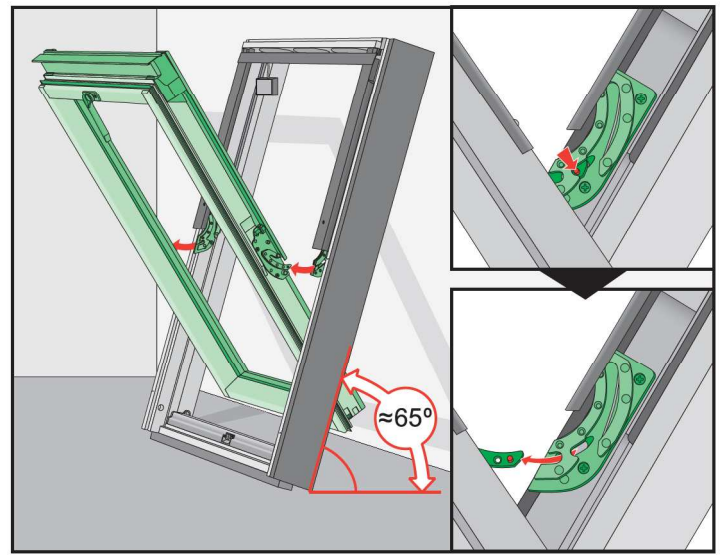
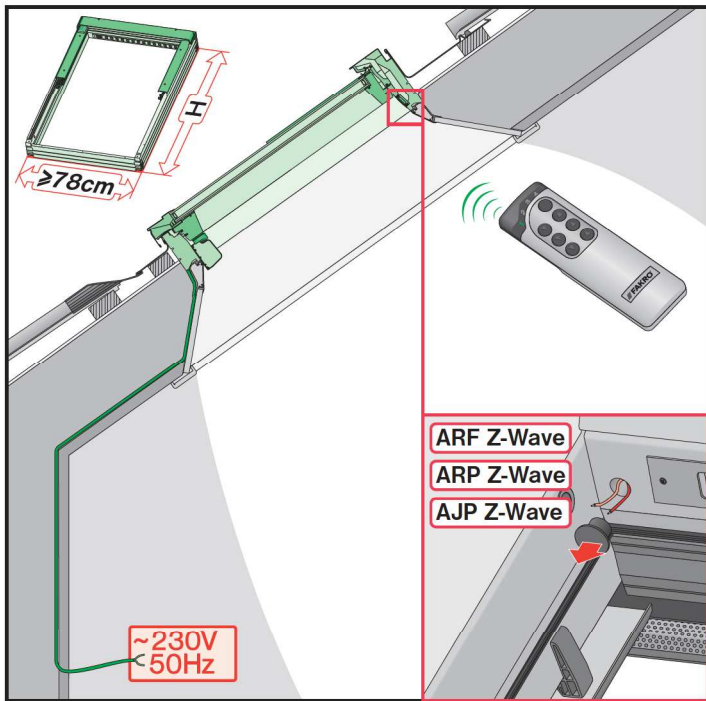
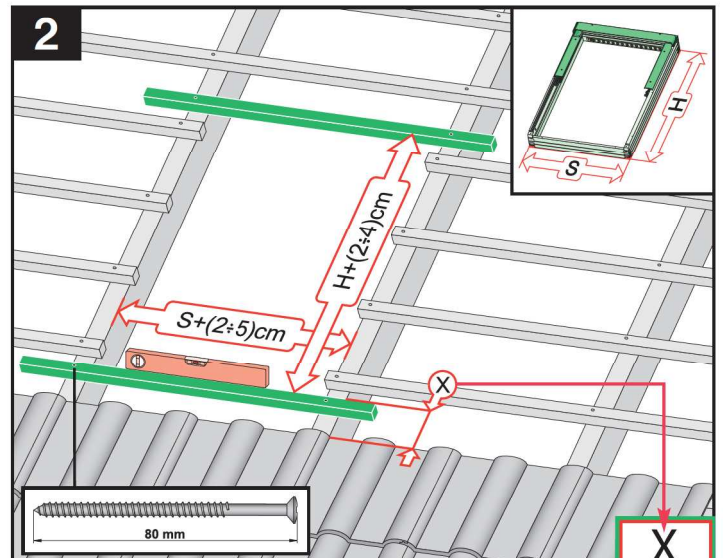
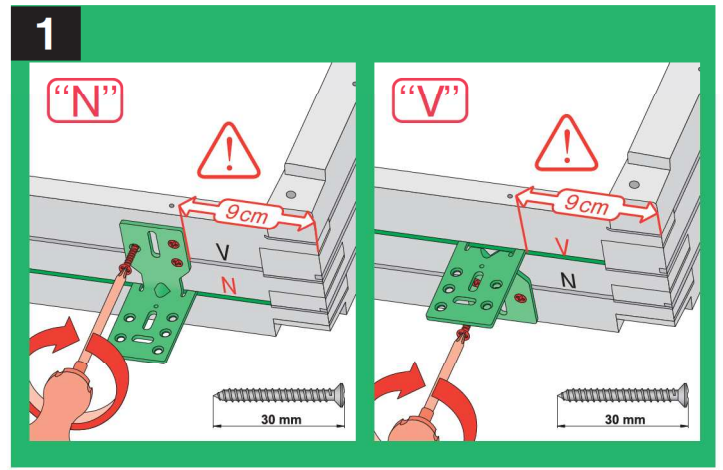
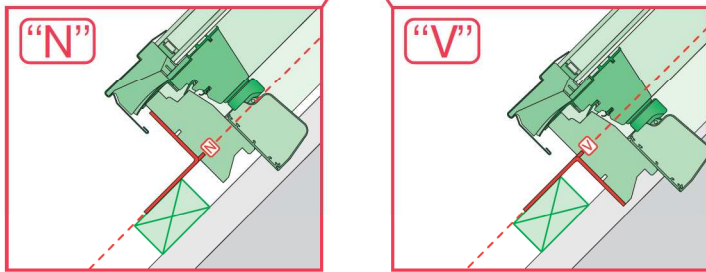
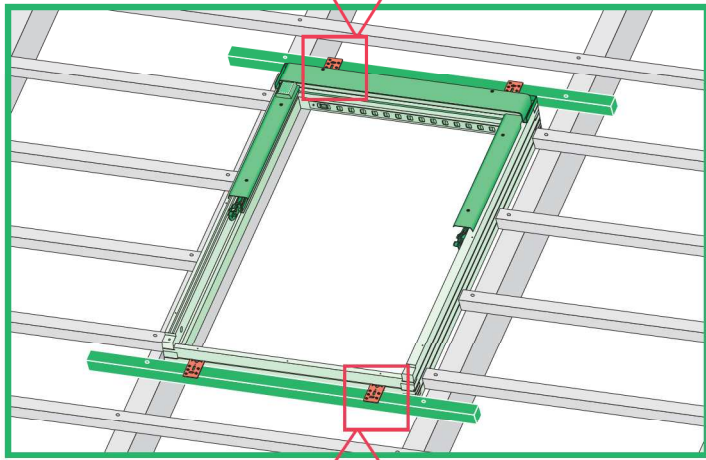
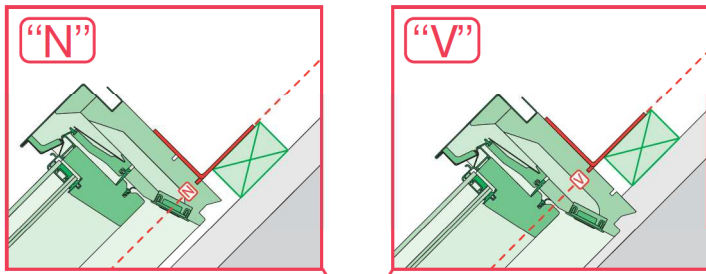

	max 90mm	EHN	7-10cm
		EHV	7-10cm
	max 45mm	EZN	6-8cm
		EZV	6-8cm
	12-16mm	EGV	4cm
	12-16mm	EPV	6cm
	max 5mm (V) max 15mm (N)	ELN	0-2cm
		ELV	0-2cm
		EEN	0-2cm
		EEV	0-2cm

	max 90mm	EHN		15°-90°
		EHV		15°-90°
		-		-
	max 45mm	EZN		15°-90°
		EZV		15°-90°
		-		-
	max 15mm (N) max 5mm (V)	ELN		15°-90°
		ELV		15°-90°
		-		-
	max 5mm	ESN		15°-90°
		ESV		15°-90°
		-		-

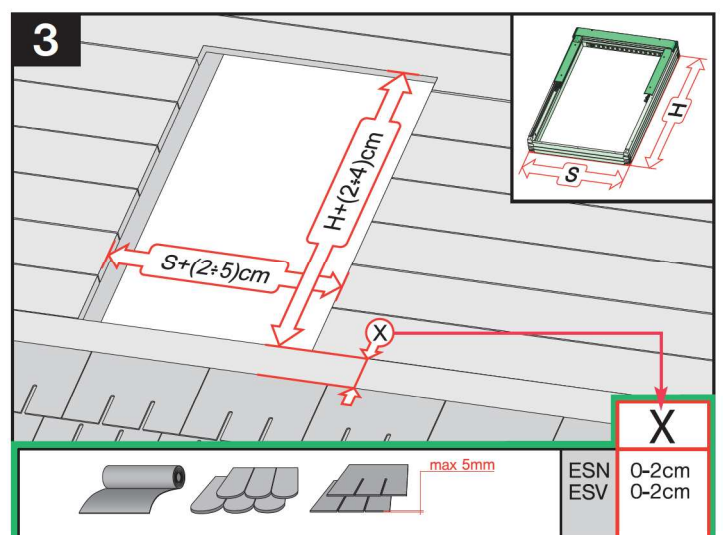

	max 5mm	ESN	0-2cm
		ESV	0-2cm

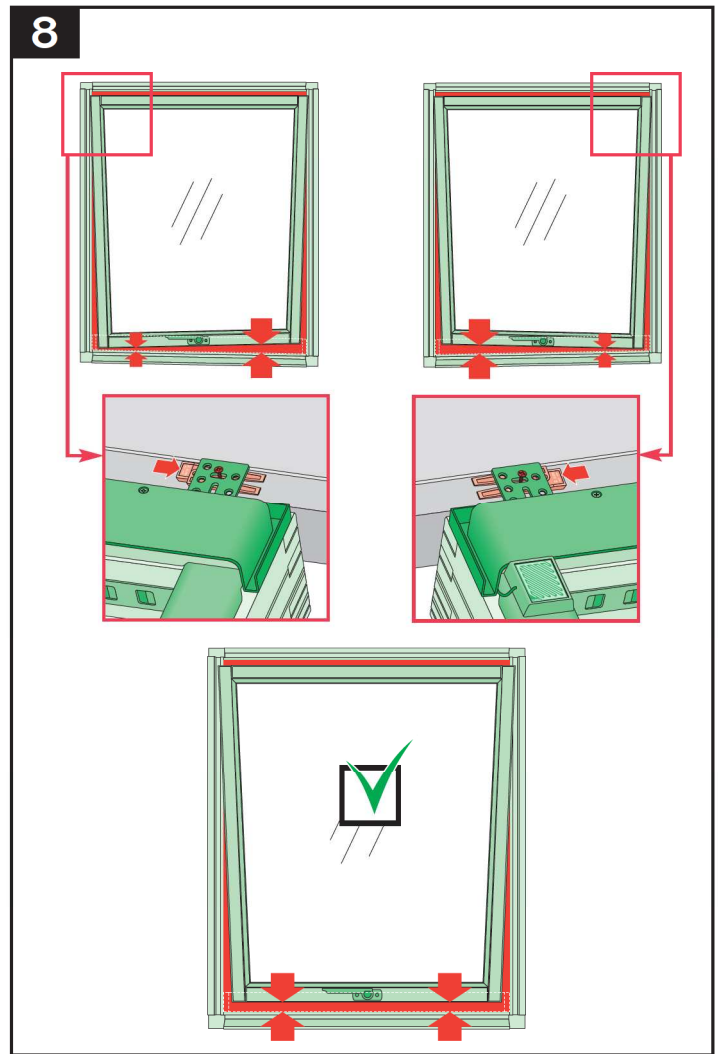
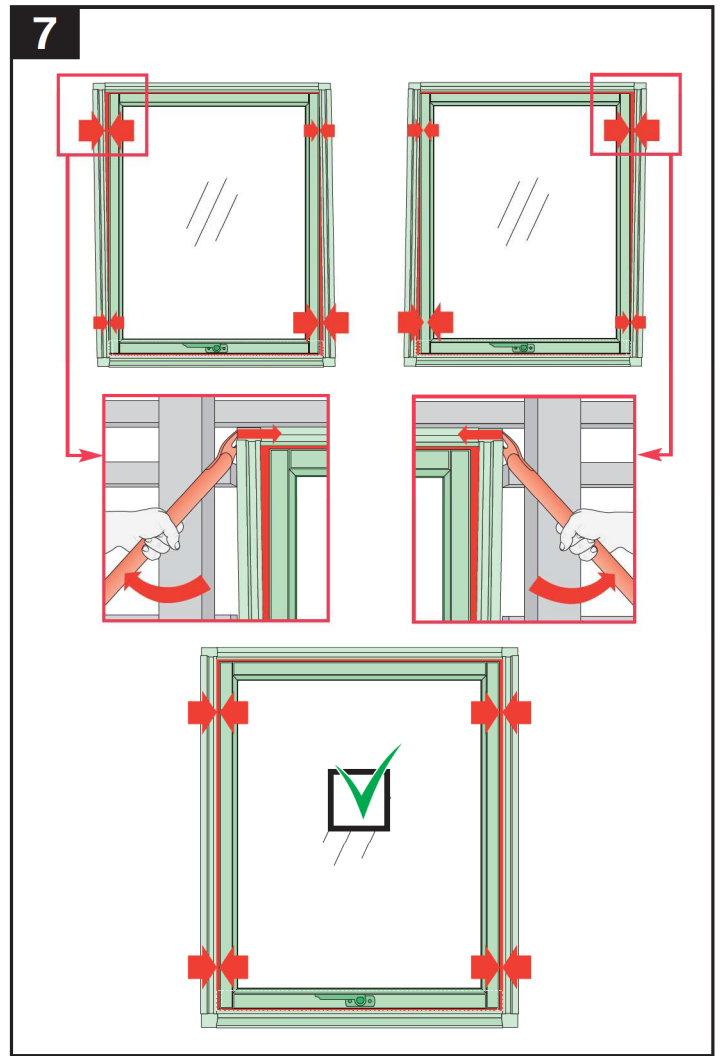
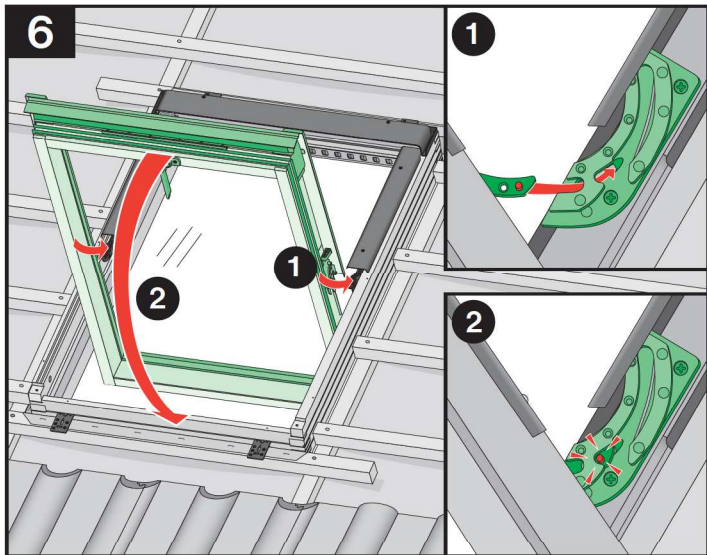
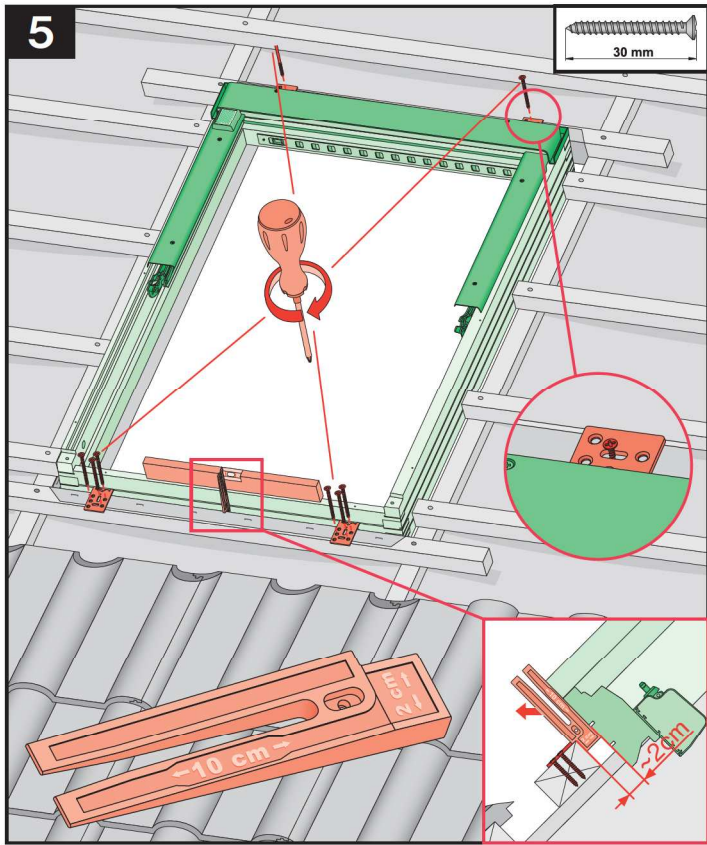
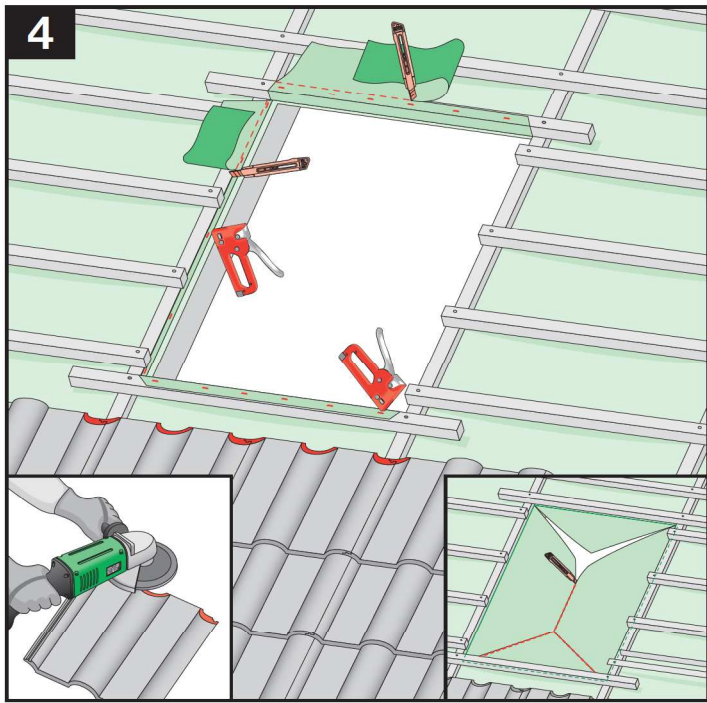

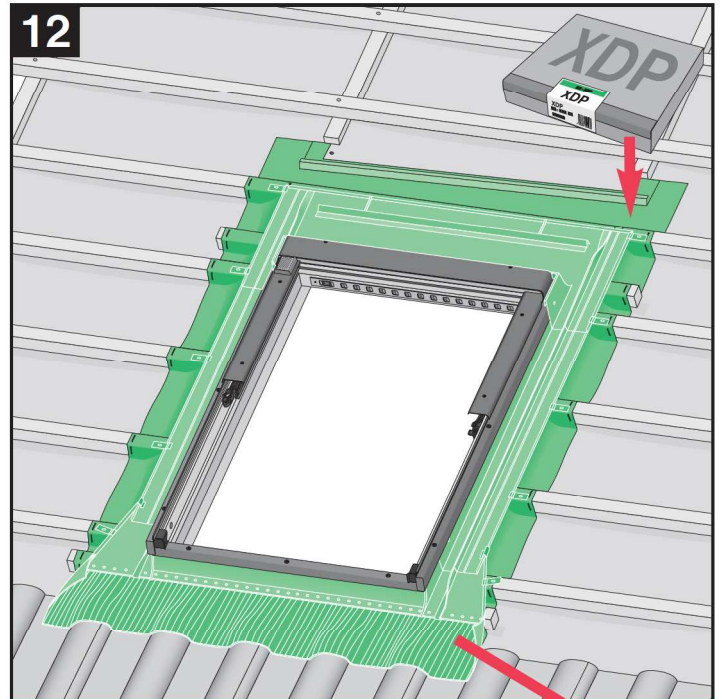
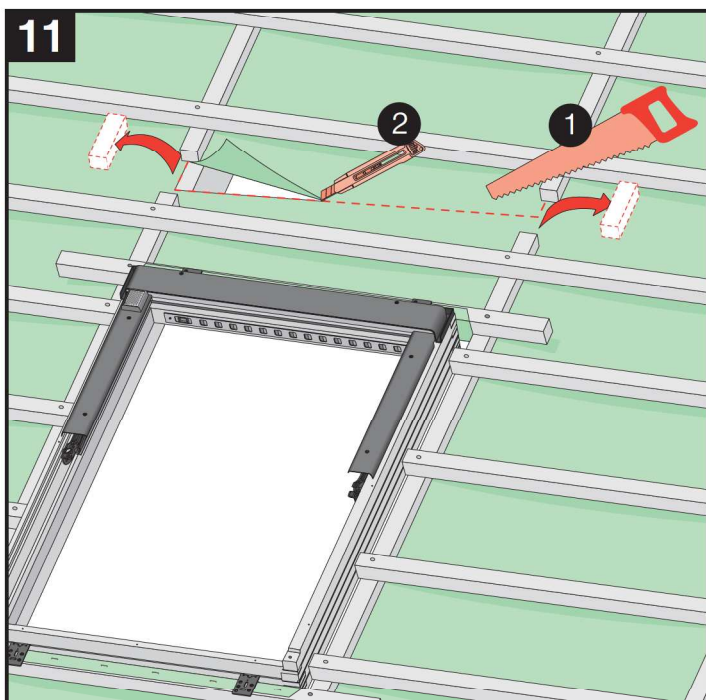
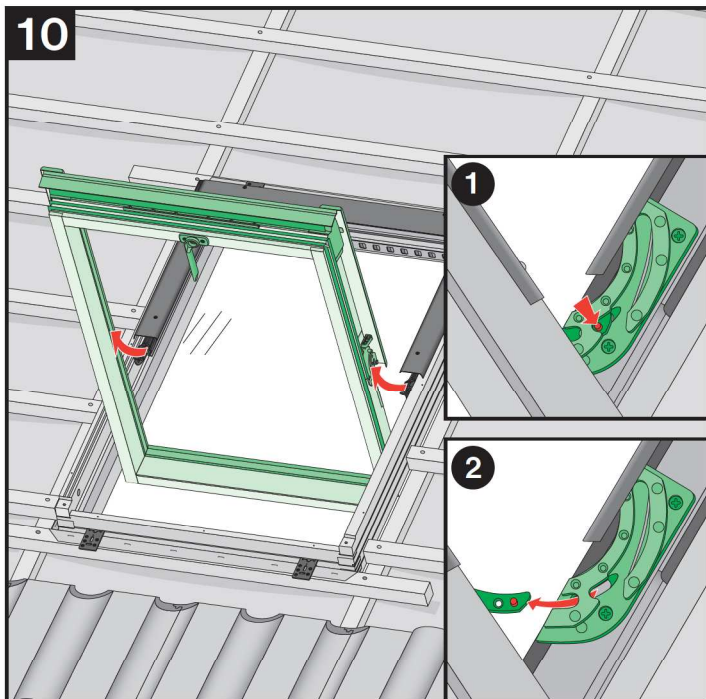
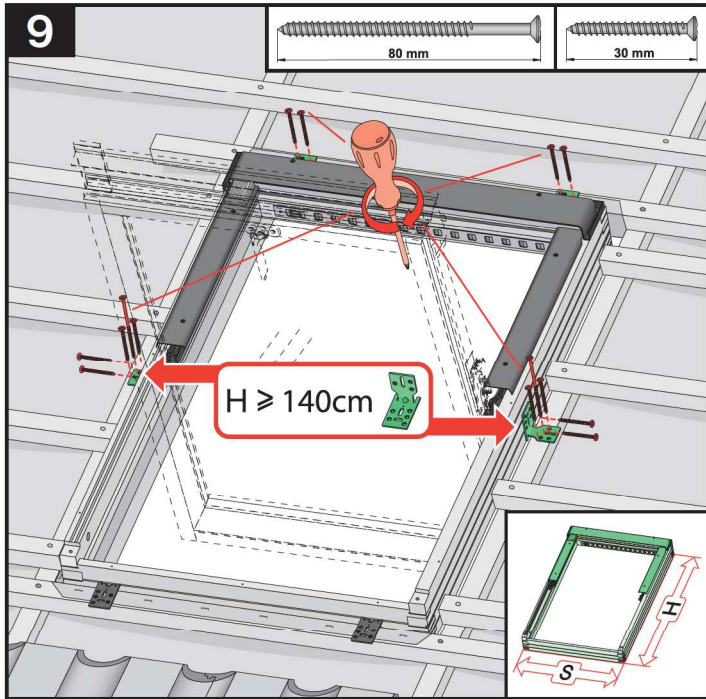

	EHN EHV
	EZN EZV
	ESN ESV
	EGV
	EPV
	ELN ELV
	EEN EEV

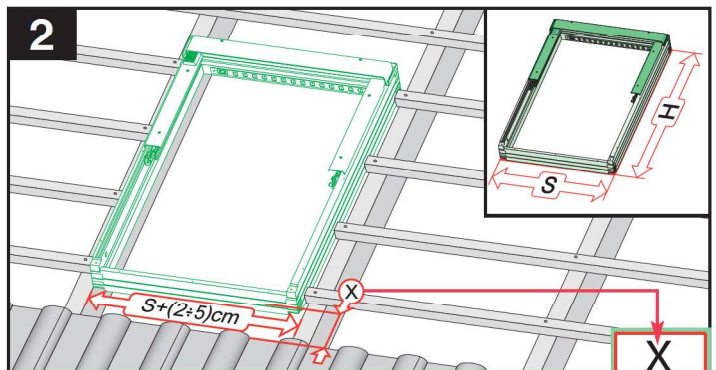
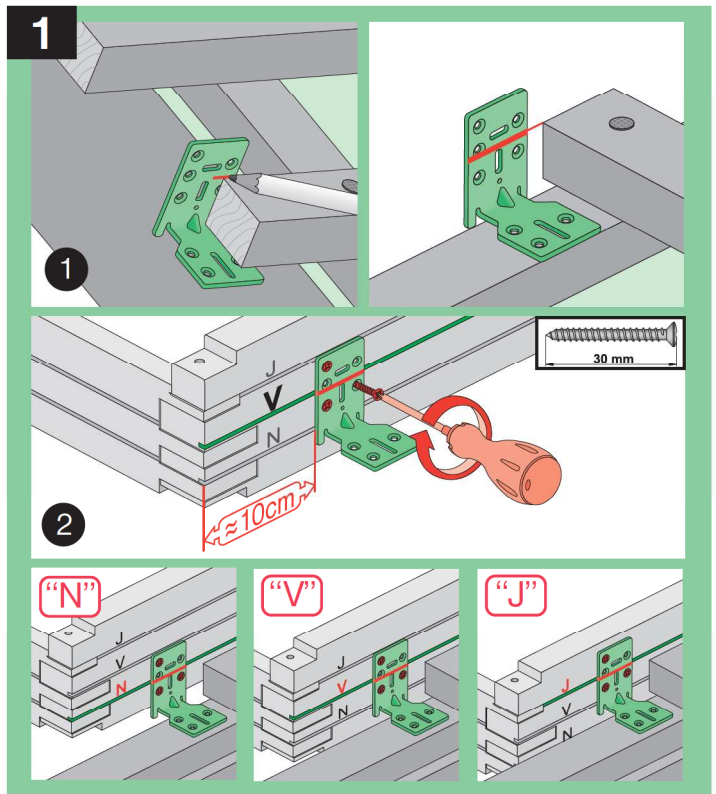
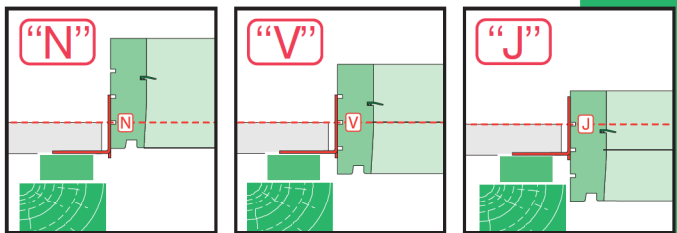
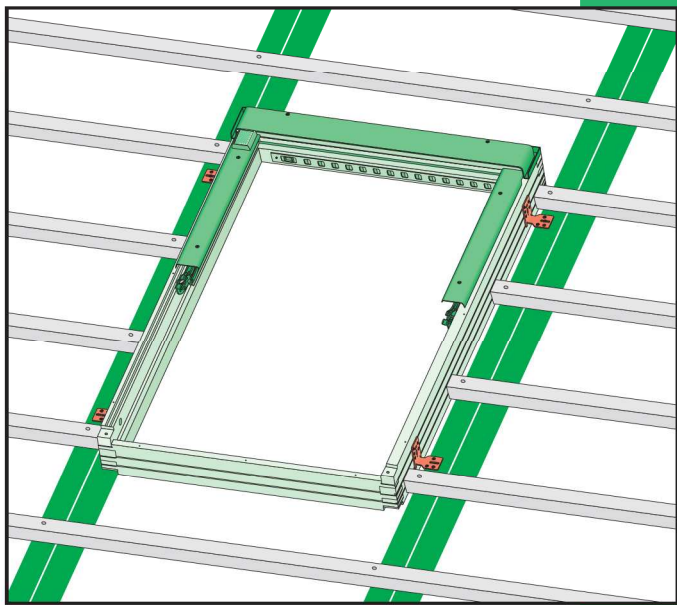



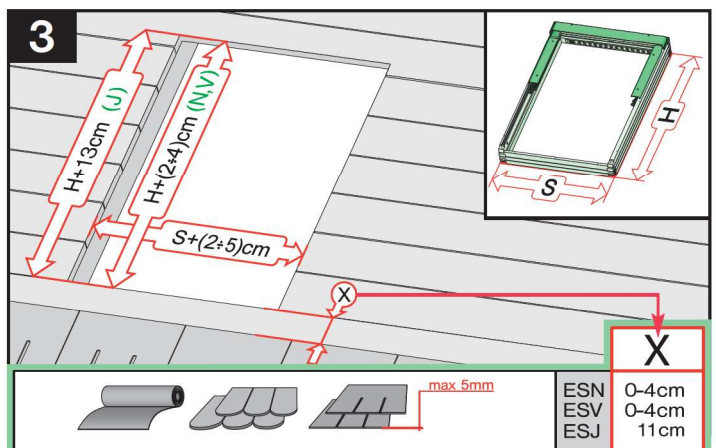



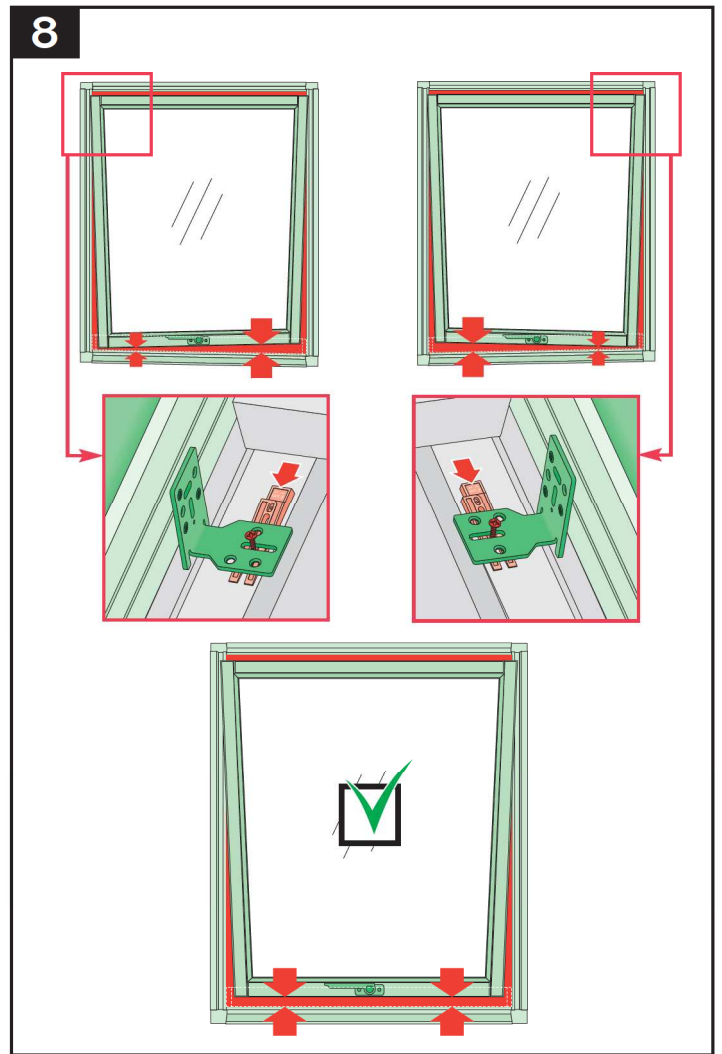
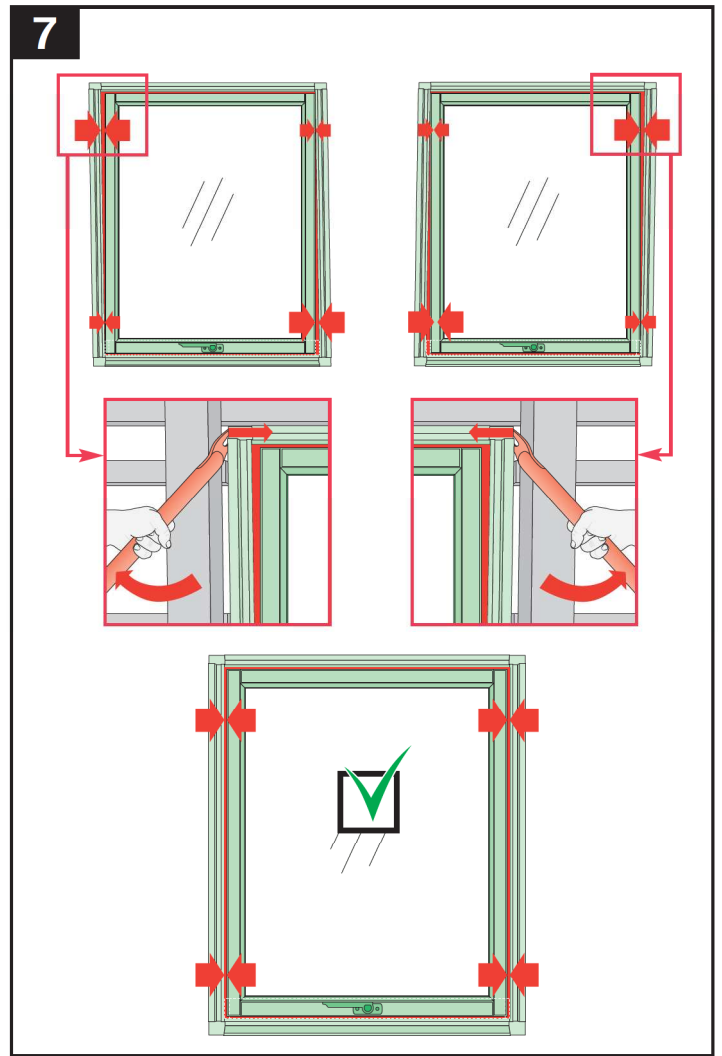
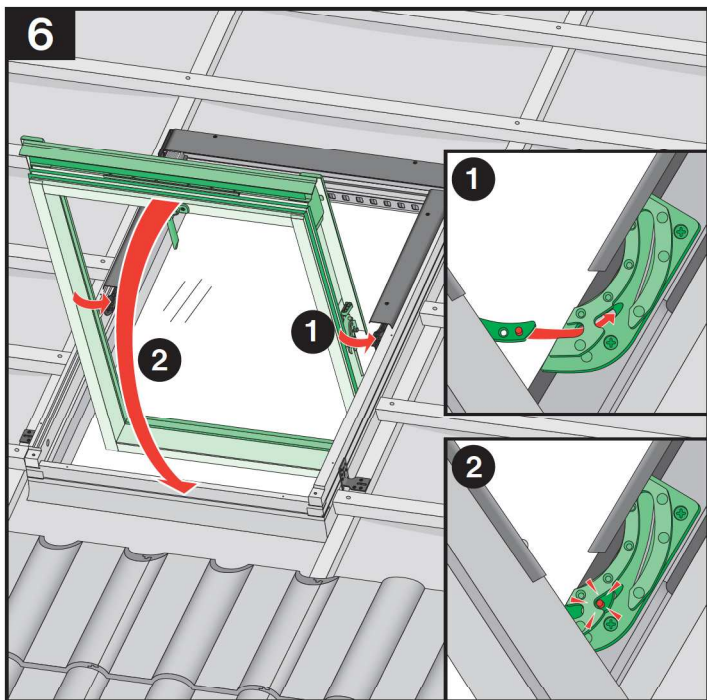
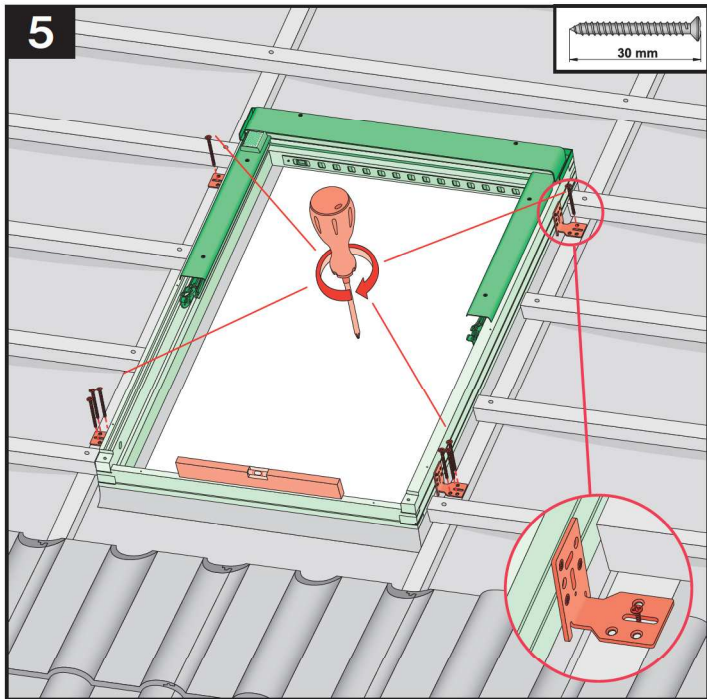
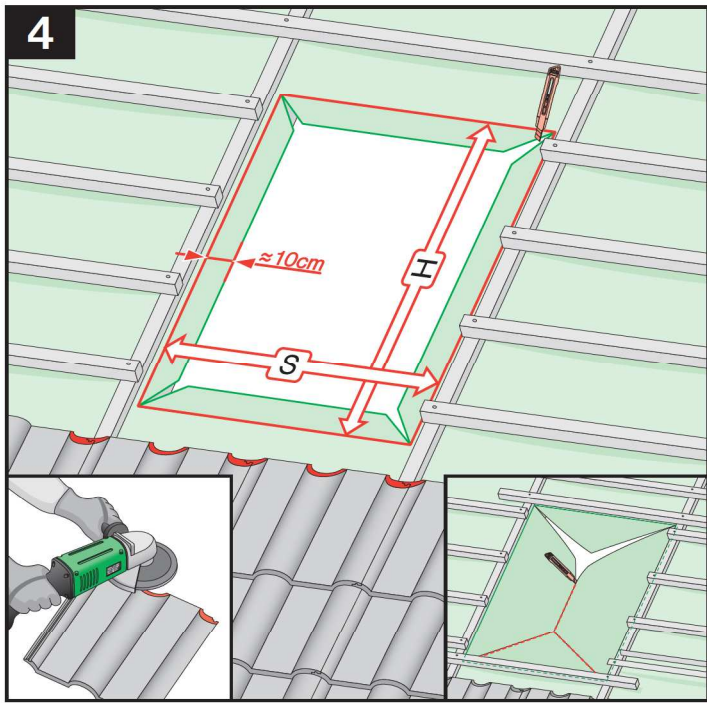

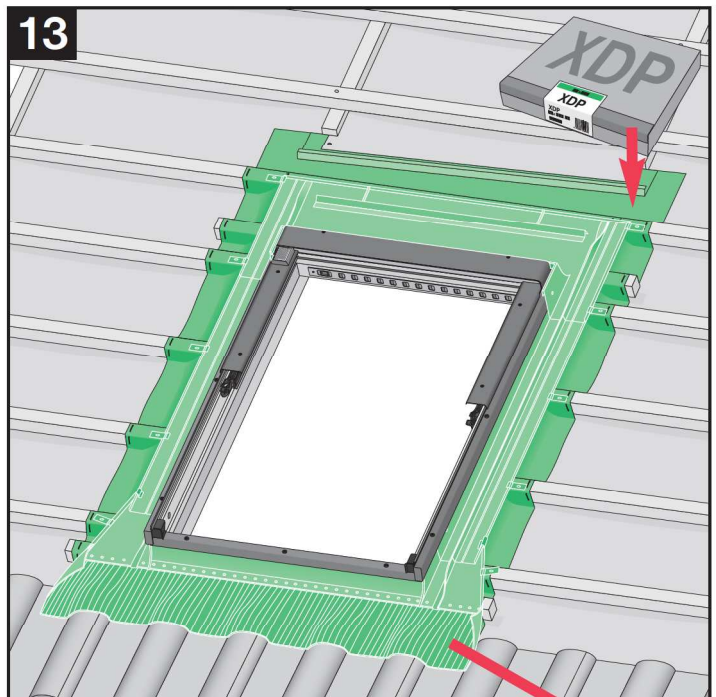
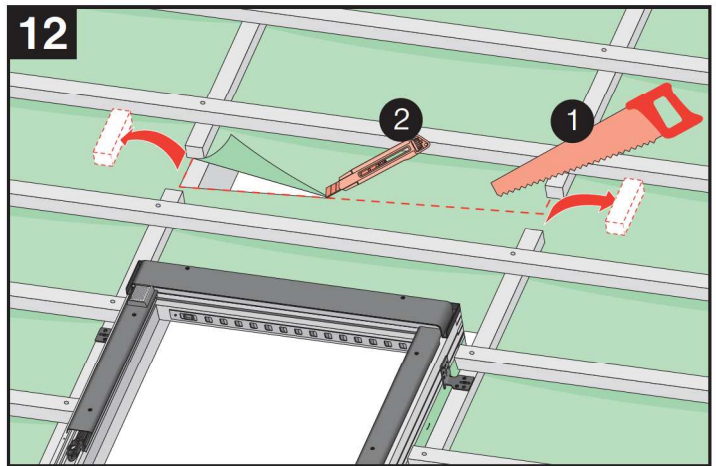
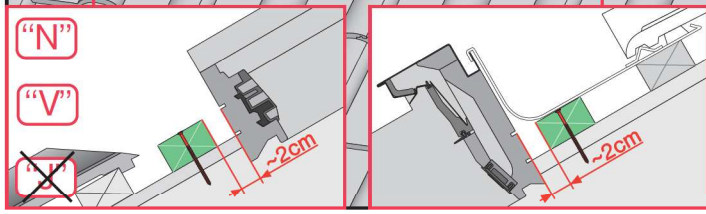
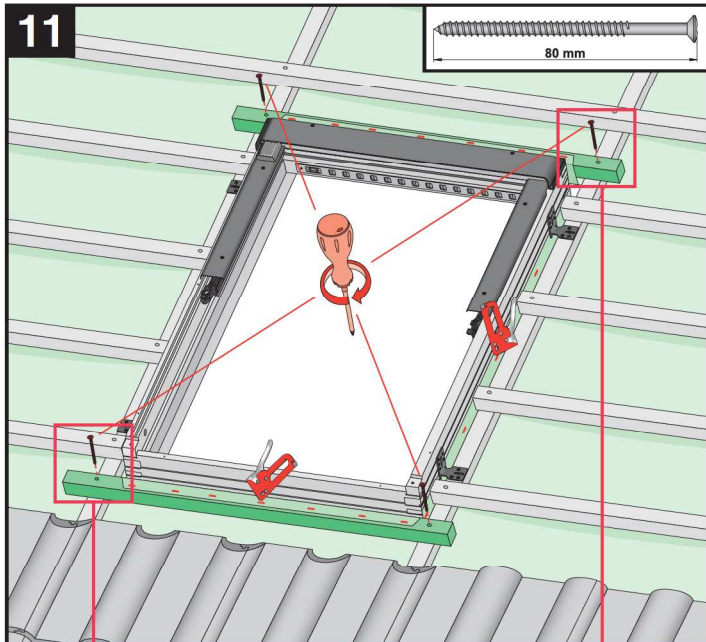
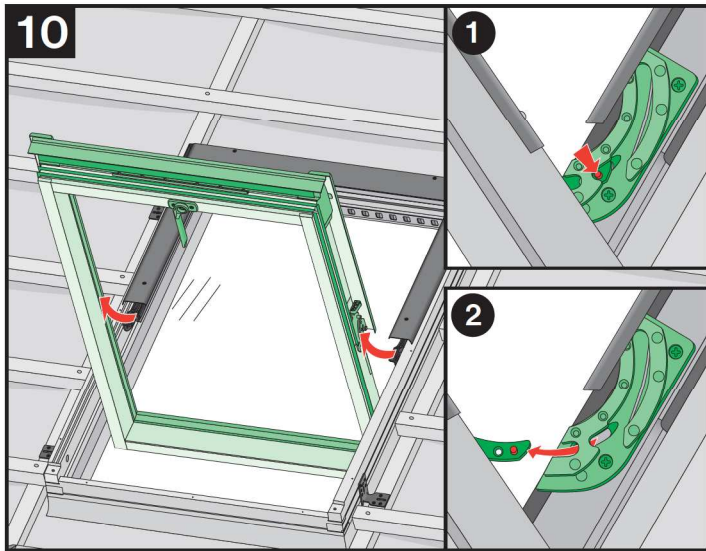
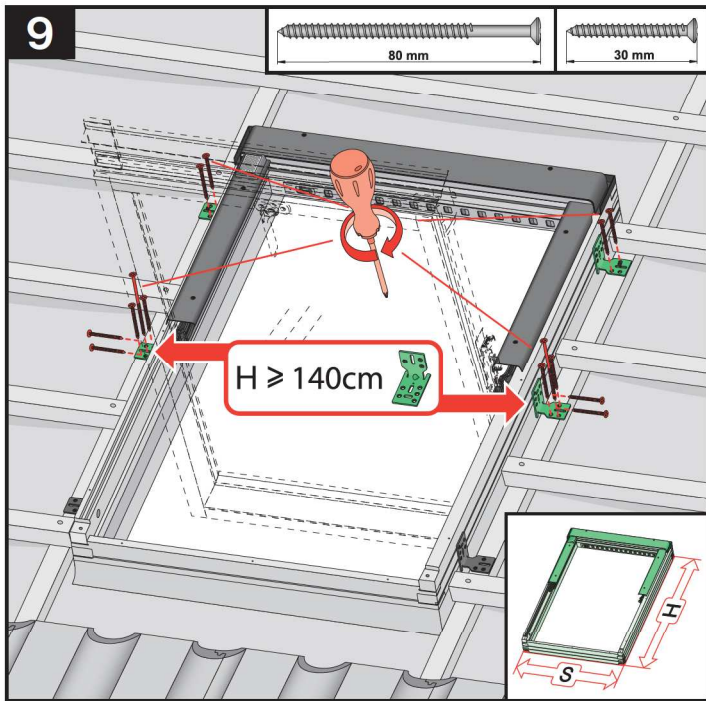













			max 90mm	EHN	9-12cm
			max 90mm	EHV	9-12cm
			max 45mm	EZN	8-10cm
			max 45mm	EVZ	8-10cm
			20-22mm	EZJ	20cm
			12-16mm	EGV	6cm
			max 18mm	EPV	8cm
			max 5mm (V,J) max 15mm (N)	ELN	0-4cm
			max 5mm (V,J) max 15mm (N)	ELV	0-4cm
			max 5mm (V,J) max 15mm (N)	ELJ	11cm
				EEN	0-4cm
				EEV	0-4cm
				EEJ	11cm



			max 5mm	ESN	0-4cm
			max 5mm	ESV	0-4cm
			max 5mm	ESJ	11cm





			max 90mm	EHN EHV
			max 45mm	EZN EZV EZJ
			max 5mm	ESN ESV ESJ
			12-16mm	EGV
			max 18mm	EPV
			max 5mm (V,J) max 15mm (N)	ELN ELV ELJ
				EEN EEV EEJ

CZ Výrobce a Prodávce nenesú žádnou odpovědnost za nedodržení příslušných předpisů zákona, stavebních předpisů a bezpečnostních požadavků ples uživatele výrobku, architekta, montéra nebo majitele objektu.

D Hersteller und Verkäufer übernehmen keine Haftung für Nichtbeachtung entsprechender Rechts- und Bauvorschriften sowie Sicherheitsanforderungen seitens Produktbenutzers, Architekten, Monteurs oder Gebäudebesitzers.

E El fabricante y el vendedor no tienen ninguna responsabilidad por el incumplimiento de la ley vigente, normas de construcción y exigencias de seguridad por parte del usuario del producto, arquitecto, instalador o el propietario del edificio.

FR Le fabricant et le revendeur ne prend aucune responsabilité de ne pas respecter les lois applicables, les règlements sur les bâtiments et les exigences de sécurité par l'utilisateur du produit, l'architecte, l'installateur ou le propriétaire du bâtiment.

GB Manufacturer and Seller shall bear no liability for failure to comply with the applicable laws, building codes and safety requirements by the user of the product, architect, fitter or owner of the building.

H A gyártó és a forgalmazó nem vállal semmilyen felelősséget a vonatkozó törvényi, építési és biztonsági előírások, termékelhasználói, építész, beszálló/mester vagy építéltulajdonos által nem tartásáért.

I Il Produttore e il Rivenditore non potranno essere ritenuti responsabili per il mancato rispetto, da parte dell'utente del prodotto, del progettista, dell'installatore o del proprietario dell'edificio, delle leggi vigenti, nonché dei regolamenti edilizi e di quelli relativi alla sicurezza.

NL De fabrikant en verkoper zijn niet aansprakelijk voor gevolgen bij het niet opvolgen van toepasselijke wetten, bouwbesluiten en veiligheidsvoorschriften door de gebruiker van het product, de architect, de installateur of de eigenaar van het gebouw.

PL Producent i Sprzedawca nie ponosi żadnej odpowiedzialności za nieprzestrzeganie stosownych przepisów prawa, przepisów budowlanych i wymogów bezpieczeństwa przez użytkownika produktu, architekta, montażystę lub właściciela budynku.

RU Ни производители, ни дистрибутор не сji vor assume мiоuлет de răspunde pentru nerespectarea legilor în vigoare, a legilor din domeniul construcțiilor sau a măsurilor de siguranță impuse utilizatorilor produsului, arhitecților, montajistilor sau proprietarilor clădirii.

RUS Производитель и продавец не несет ответственности за невыполнение здания строительных правил и норм безопасности ответственность с производства и продажи снимается.

SK Výrobca a predávca nenesú žiadnu zodpovednosť za nedodržanie príslušných ustanovení zákona, stavebných predpisov a bezpečnostných požiadaviek užívateľom výrobku, architektom, montérom alebo majiteľom objektu.