

25°-65° FDP-V, FDY-V

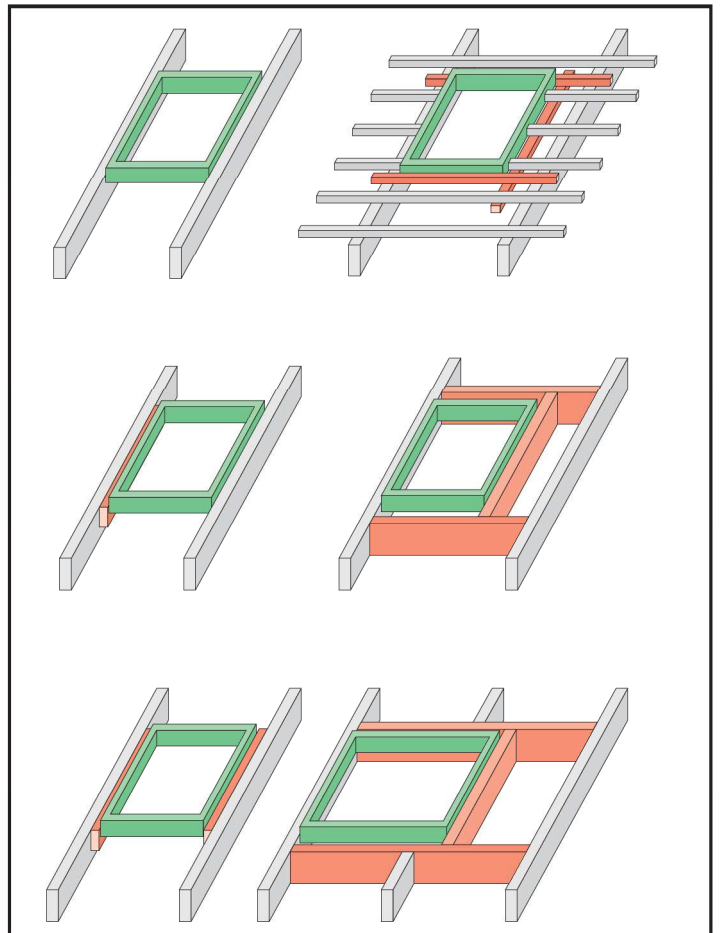

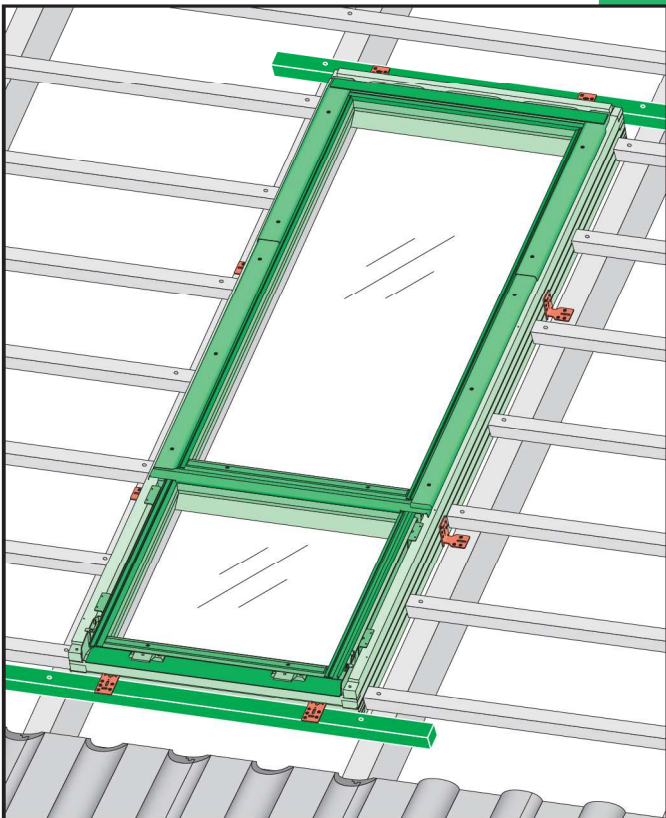

3

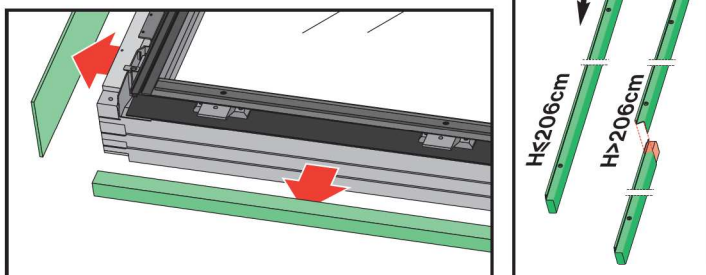
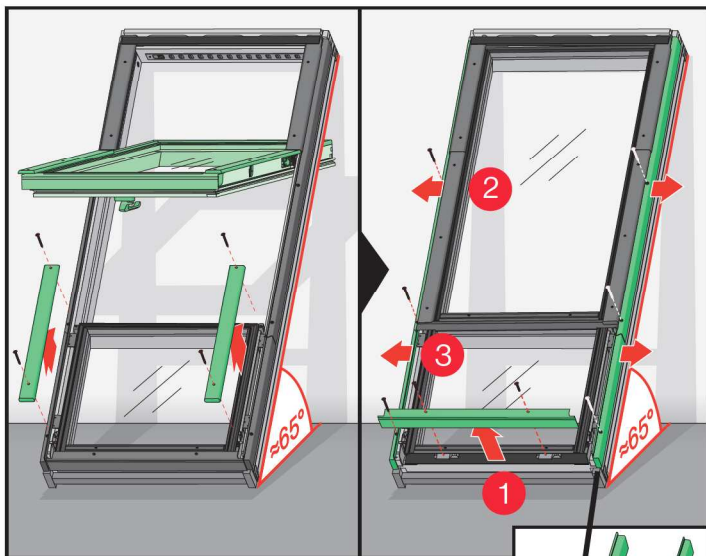
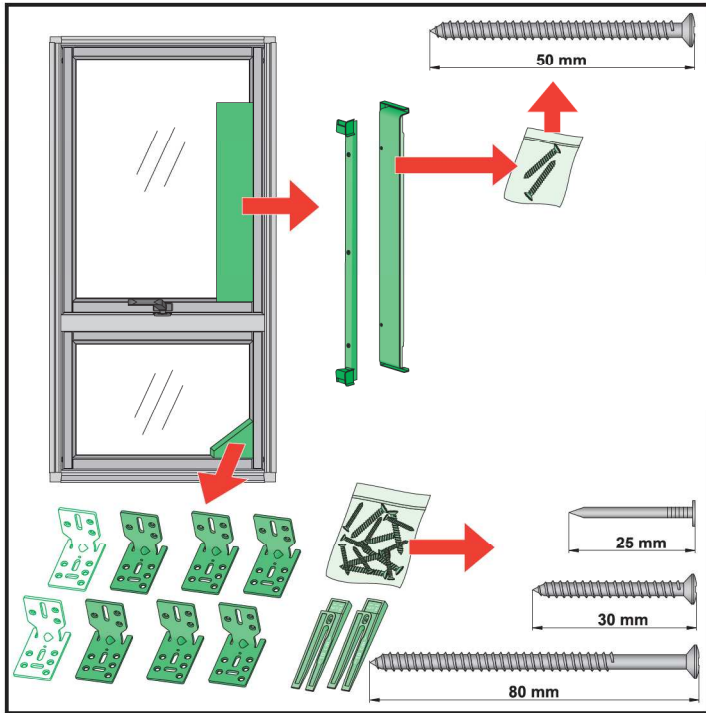
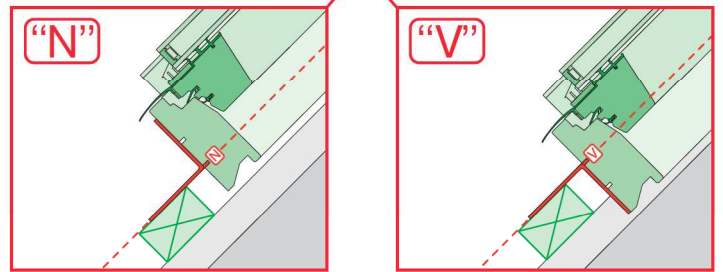
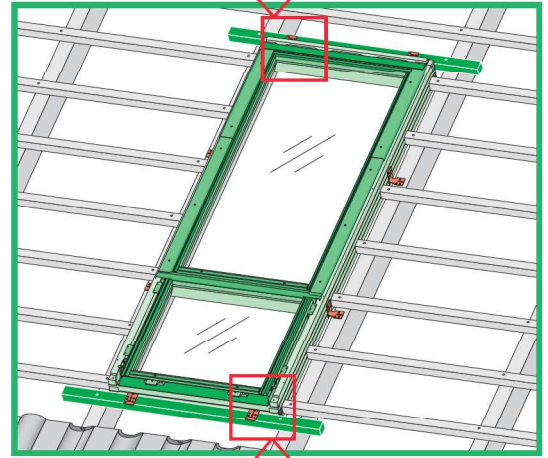
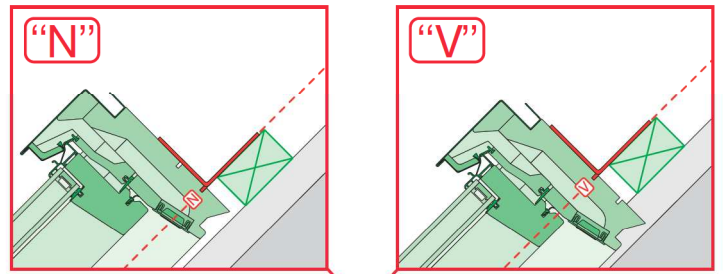

	max 90mm	EHN		
		EHV		
	max 45mm	EZN		
		EVZ		
	max 15mm (N) max 5mm (V)	ELN		
		ELV		
	max 5mm	ESN		
		ESV		

4



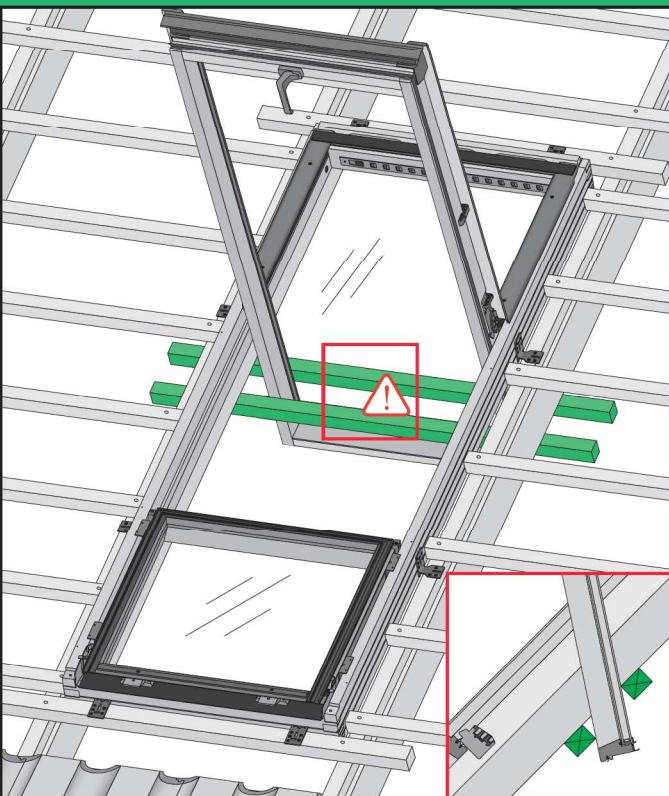
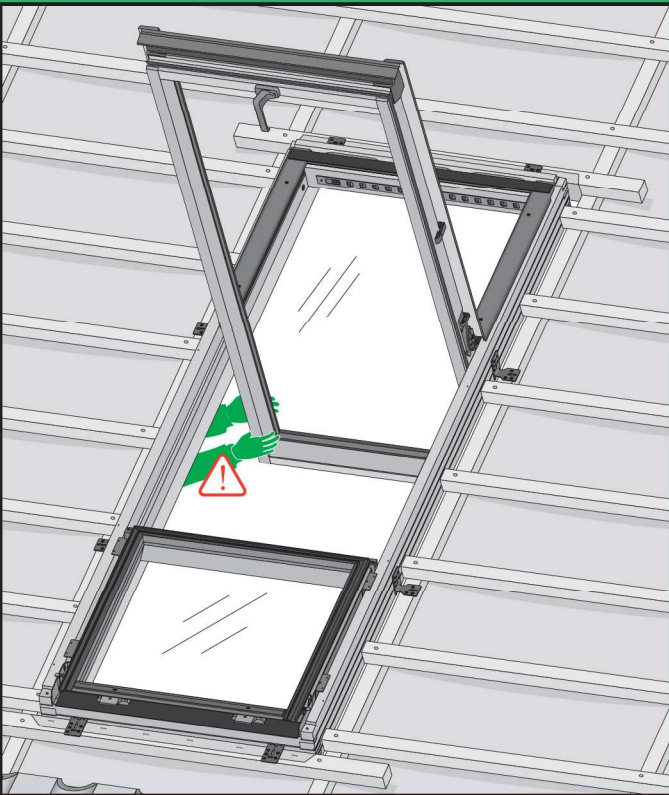
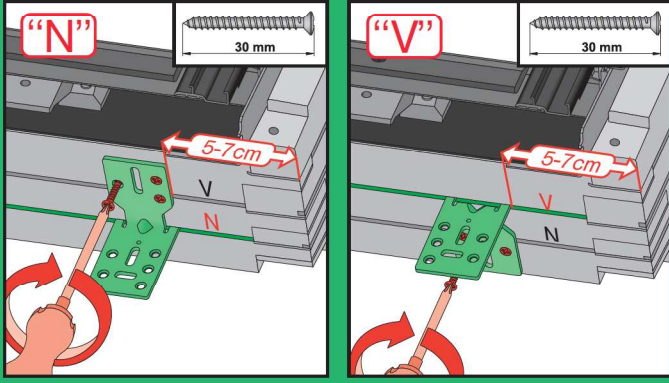





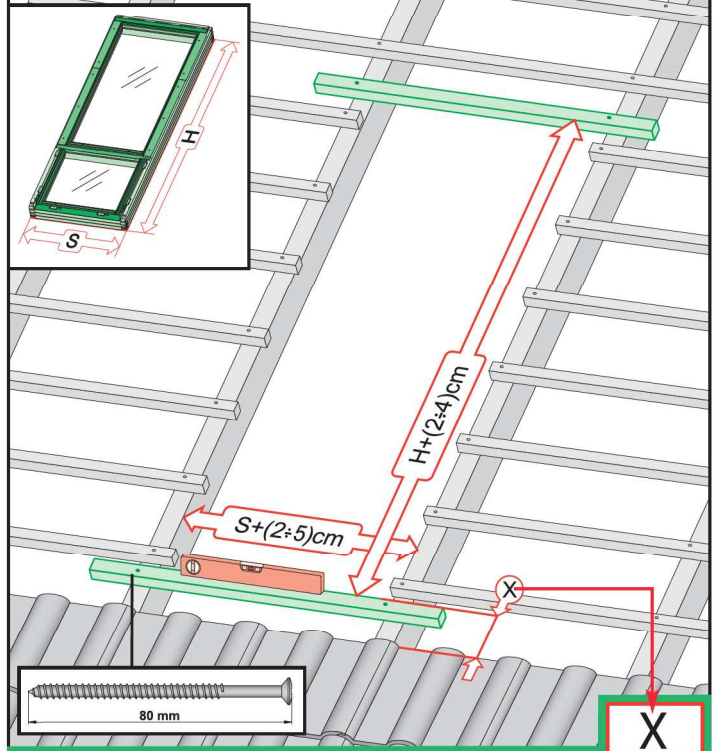



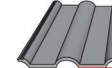

1

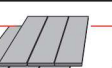

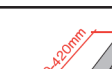
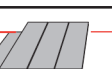
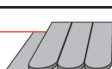
5



2

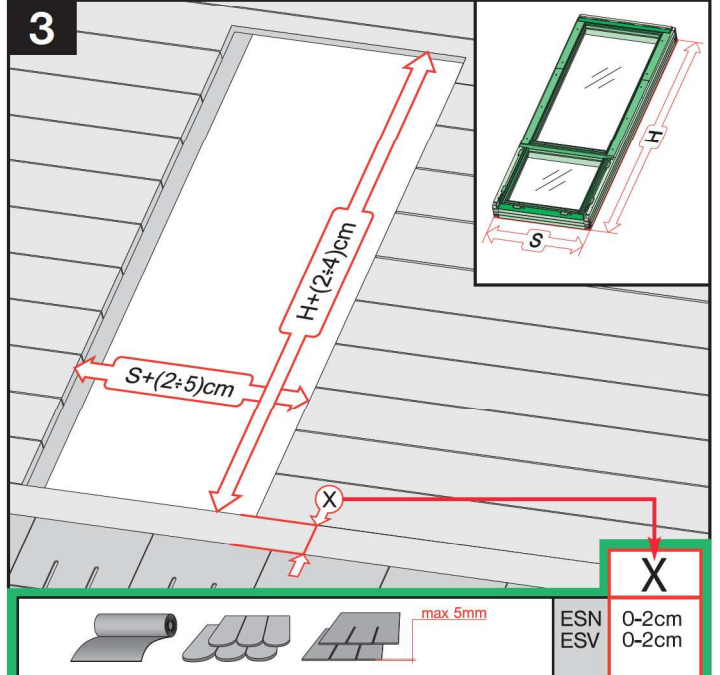

		X	
			max 90mm
EHN	EHV		7-10cm
			max 45mm
EZN	EZV		6-8cm
			12-16mm
EGV			4cm
			12-16mm
EPV			6cm
			max 5mm (V) max 15mm (N)
ELN	ELV		0-2cm
			
EEN	EEV		0-2cm

3

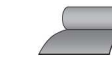

		X	
			max 5mm
ESN	ESV		0-2cm

6

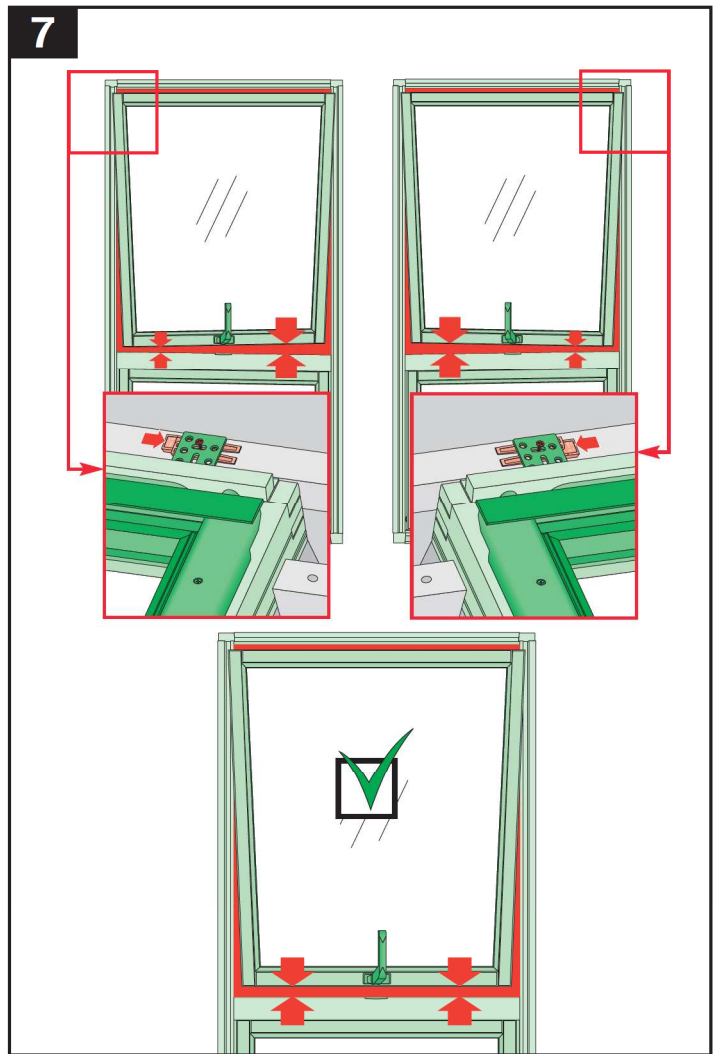
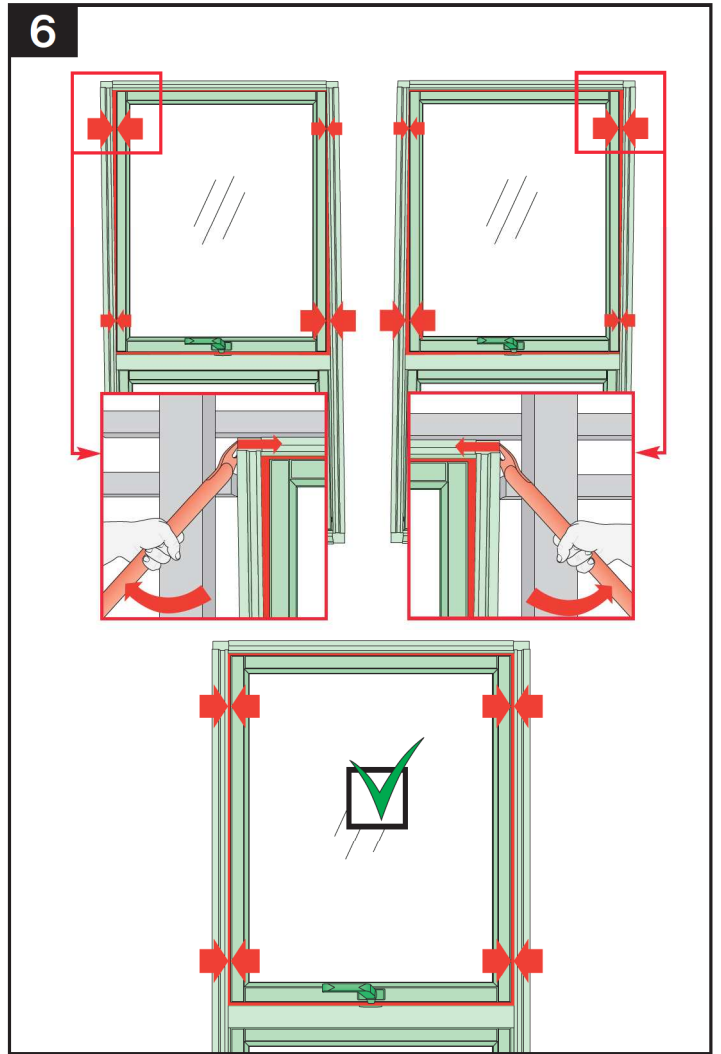
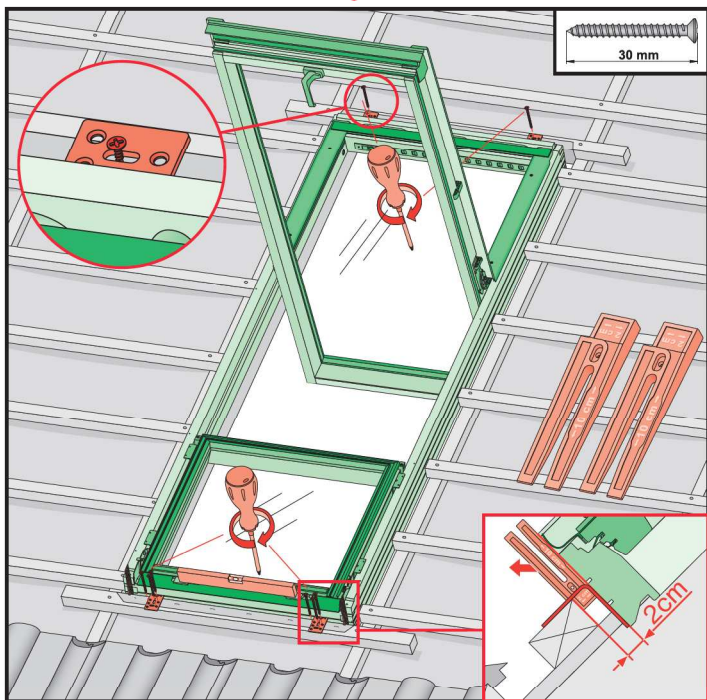
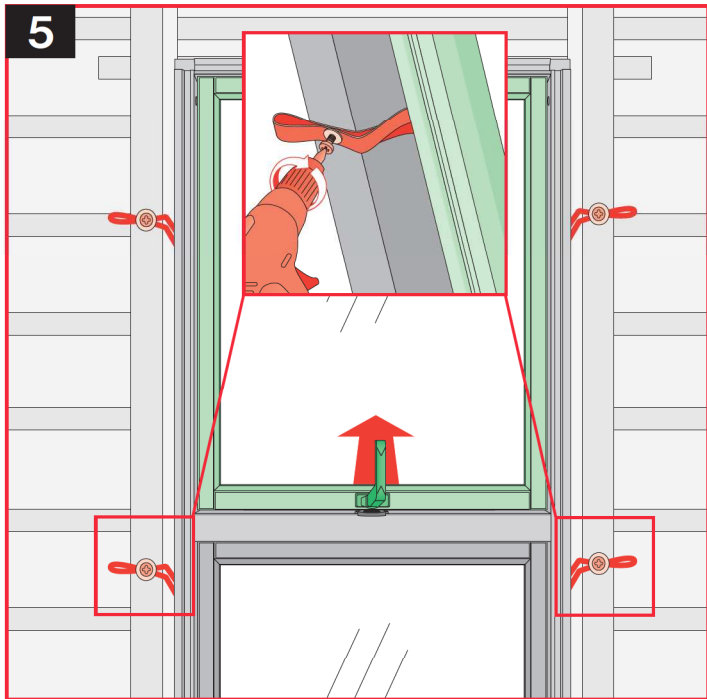
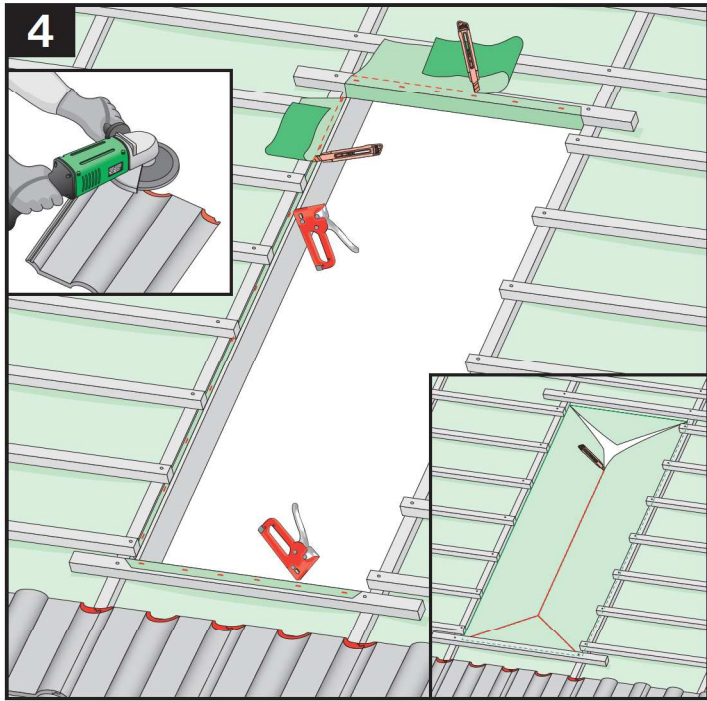

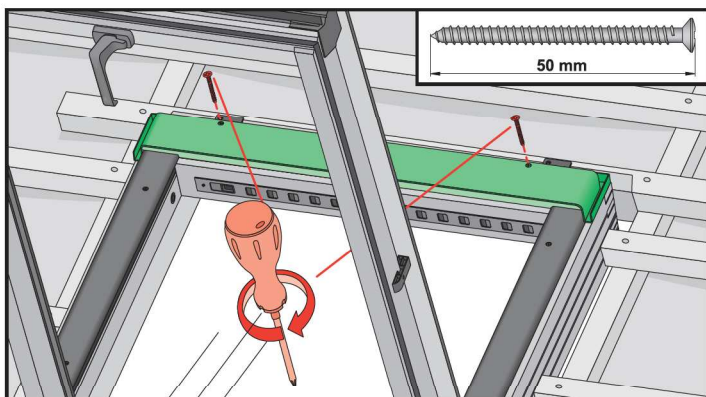
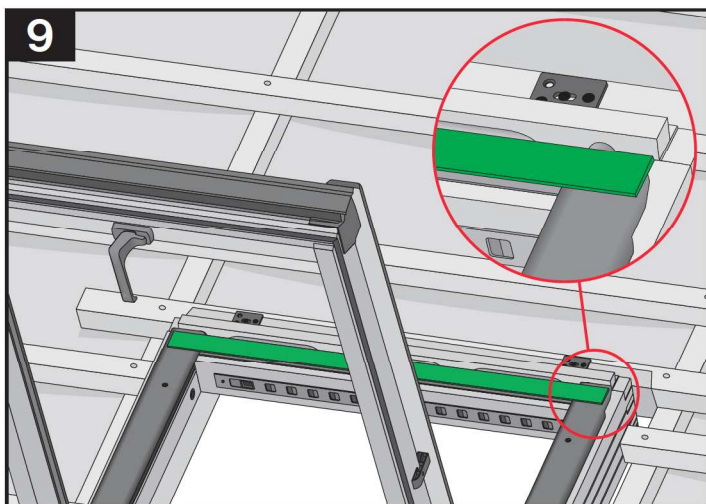
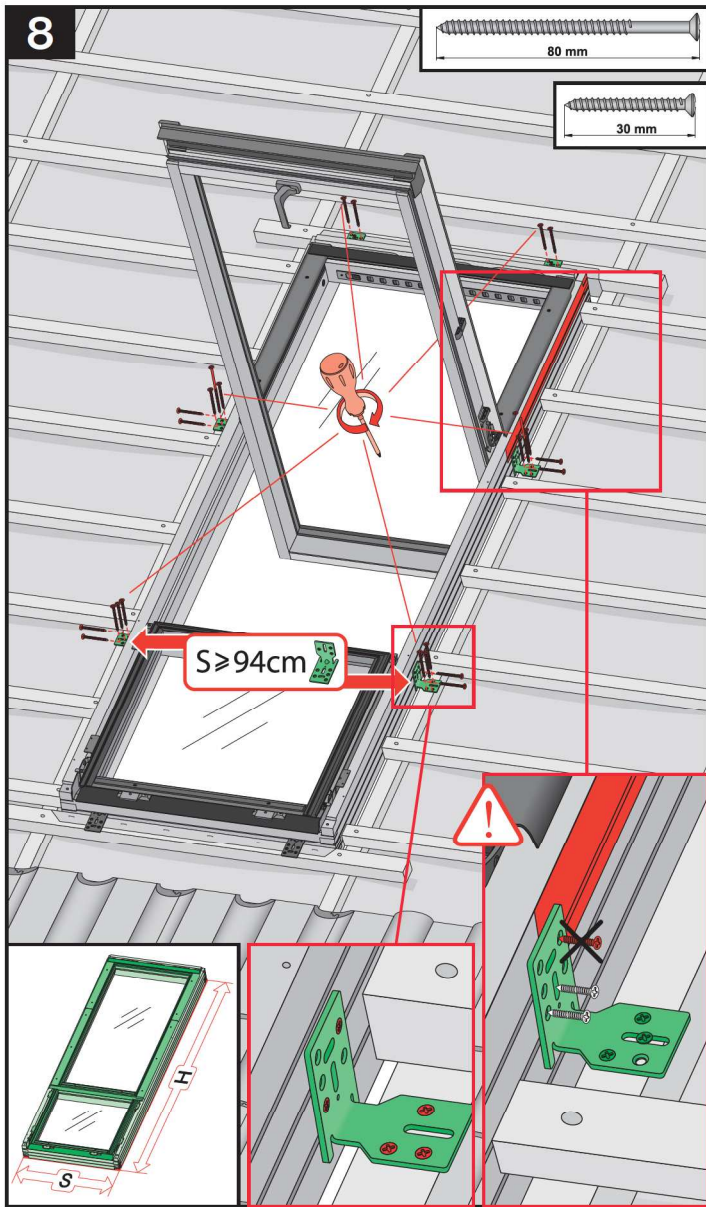

9

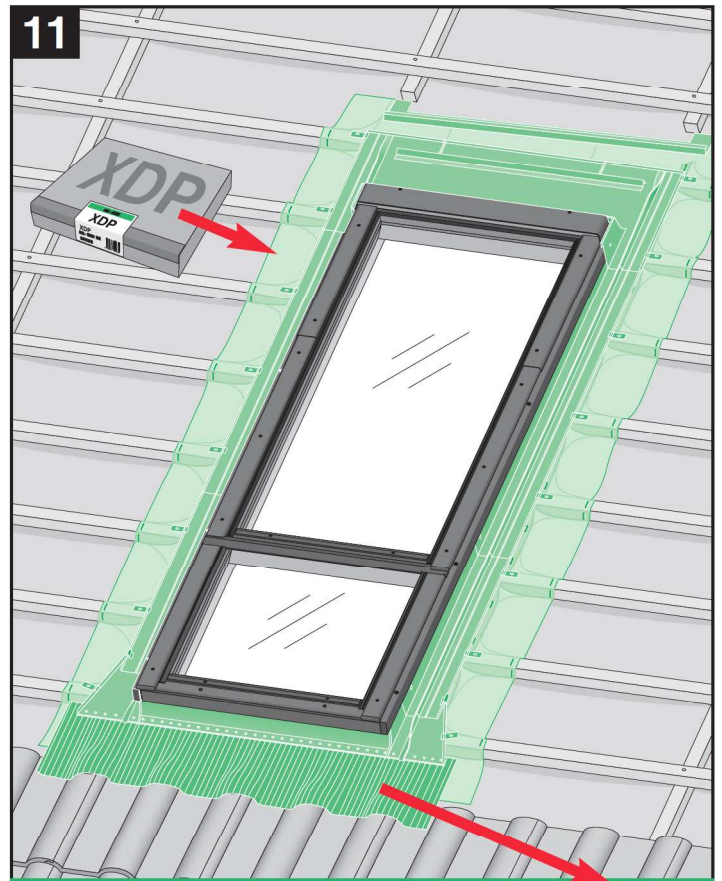
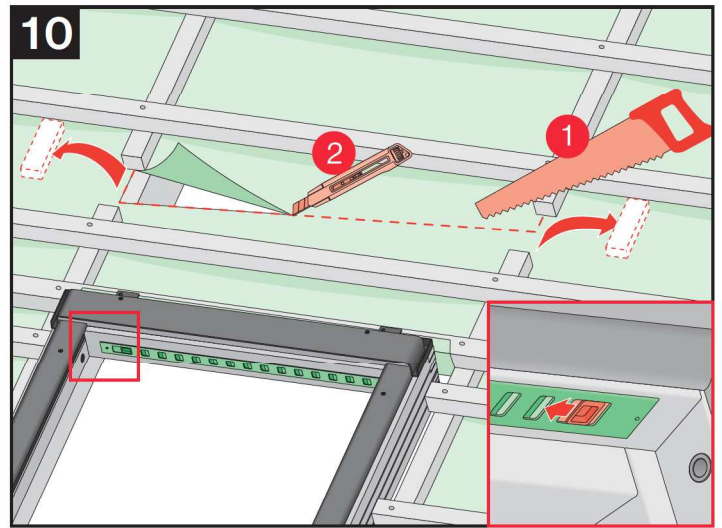

	max 90mm	EHN EHV
	max 45mm	EZN EZV
	max 5mm	ESN ESV
	380-420mm 12-16mm	EGV
	280-280mm max 18mm	EPV
	max 5mm (V) max 15mm (N)	ELN ELV
		EEN EEV

10

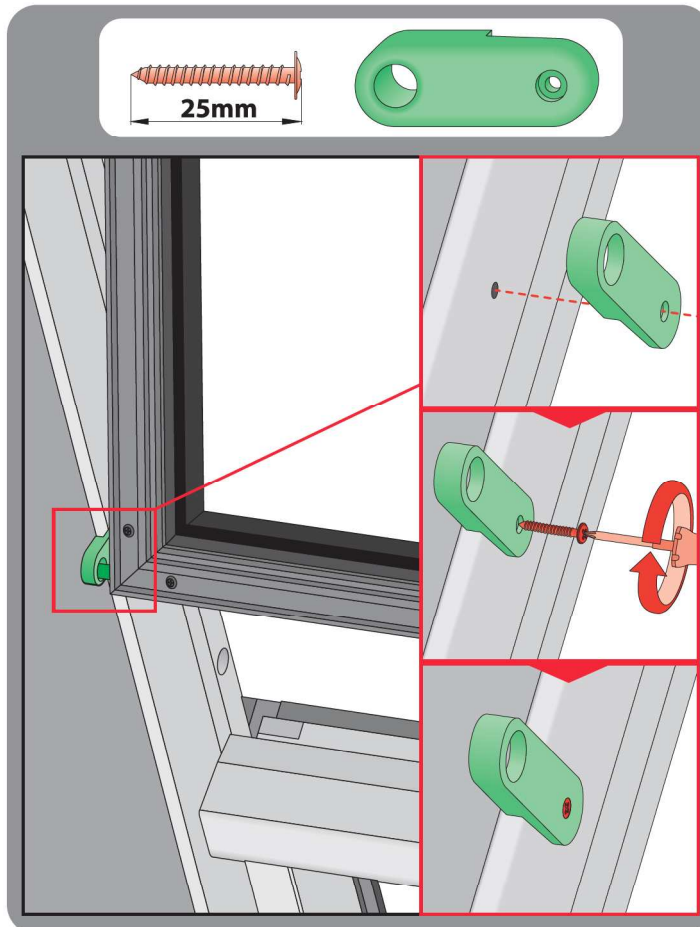
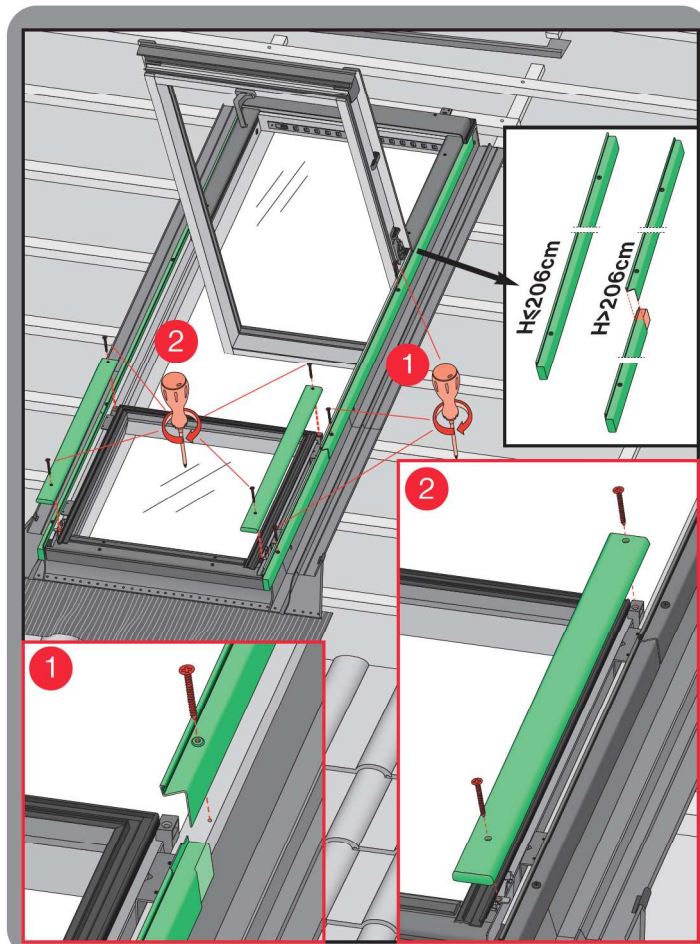
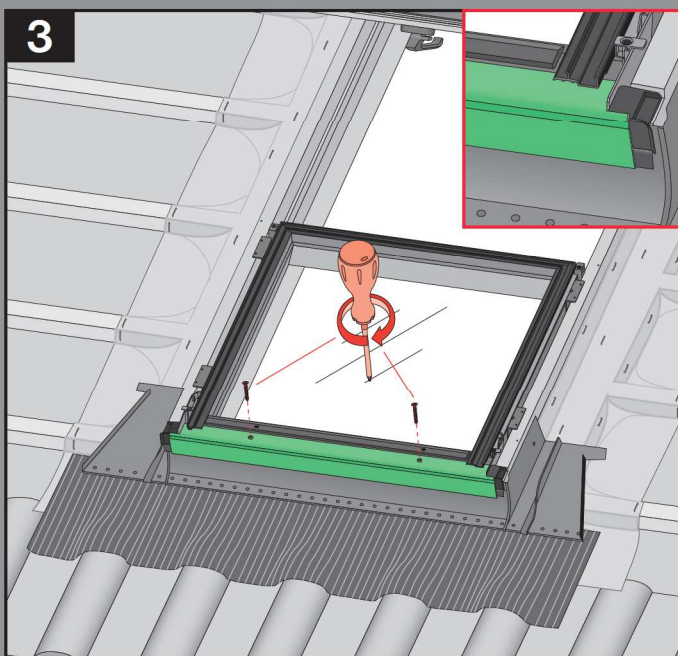
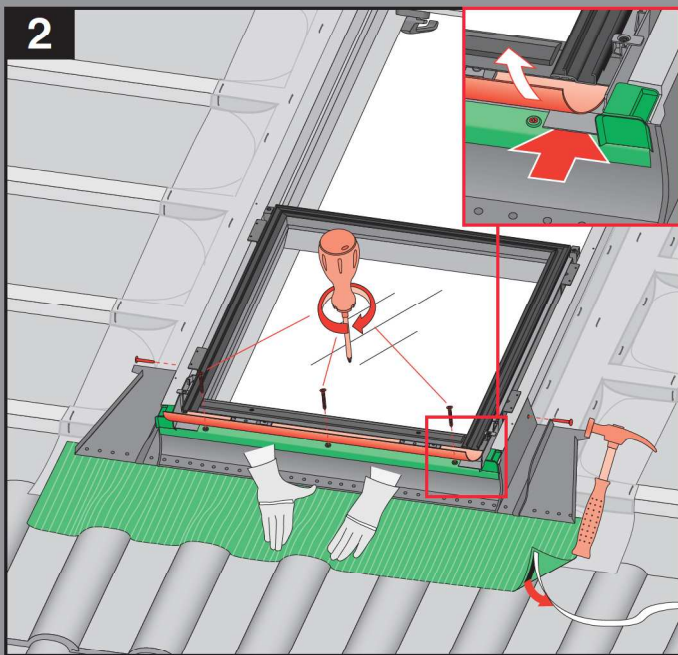
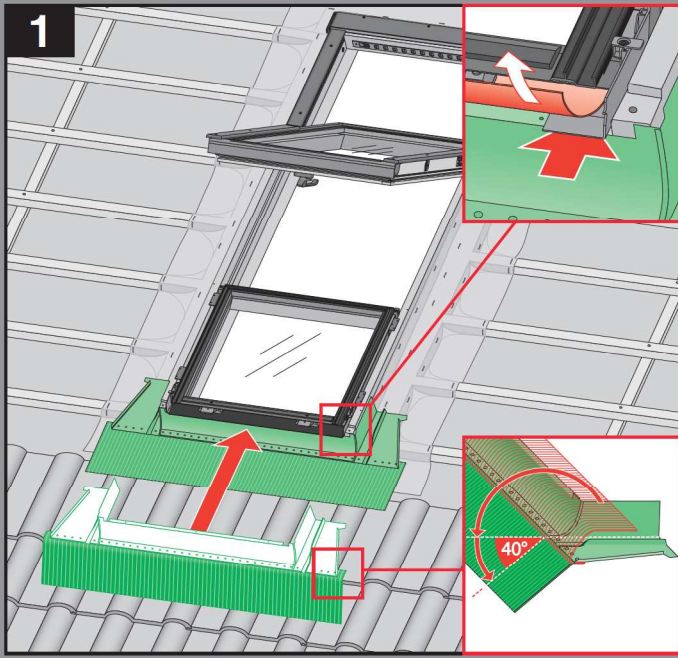
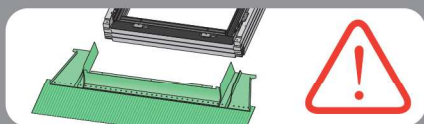

CZ Výrobce a Prodejce nenesí žádnou odpovědnost za nedodržení příslušných předpisů zákona, stavebních předpisů a bezpečnostních požadavků ples uživatele výrobku, architekta, montéra nebo majitele objektu.
D Hersteller und Verkäufer übernehmen keine Haftung für Nichtbeachtung entsprechender Rechts- und Bauvorschriften sowie Sicherheitsanforderungen seitens Produktbenutzers, Architekten, Monteure oder Gebäudebesitzers.
E El fabricante y el vendedor no tienen ninguna responsabilidad por el incumplimiento de la ley vigente, normas de construcción y exigencias de seguridad por parte del usuario del producto, arquitecto, instalador o el propietario del edificio.
FR Le fabricant et le revendeur ne prend aucune responsabilité de ne pas respecter les lois applicables, les règlements sur les bâtiments et les exigences de sécurité par l'utilisateur du produit, l'architecte, l'installateur ou le propriétaire du bâtiment.
GB Manufacturer and Seller shall bear no liability for failure to comply with the applicable laws, building codes and safety requirements by the user of the product, architect, fitter or owner of the building.
H Gyártó és Forgalmazó nem vállal semmilyen felelősséget a vonatkozó törvényi, építési és biztonsági előírások, termékbiztonsági, építési, beszerzőmester vagy építésmunkások általi nem tartásáért.

I Il Produttore e il Rivenditore non potranno essere ritenuti responsabili per il mancato rispetto, da parte dell'utente del prodotto, del progettista, dell'installatore o del proprietario dell'edificio, delle leggi vigenti, nonché dei regolamenti edilizi e di quelli relativi alla sicurezza.
NL De fabrikant en verkoper zijn niet aansprakelijk voor gevolgen bij het niet opvolgen van toepasselijke wetten, bouwbesluiten en veiligheidsvoorschriften door de gebruiker van het product, de architect, de installateur of de eigenaar van het gebouw.
PL Producent i Sprzedawca nie ponosi żadnej odpowiedzialności za nieprzestrzeganie stosownych przepisów prawa, przepisów budowlanych i wymogów bezpieczeństwa przez użytkownika produktu, architekta, montażystę lub właściciela budynku.
RU Производитель и продавец не несет ответственности за неисполнение пользователем продукта, архитектором, монтажником или владельцем здания строительных правил и норм безопасности.
RUS Производитель и продавец не несет ответственности за неисполнение пользователем продукта, архитектором, монтажником или владельцем здания строительных правил и норм безопасности.
SK Výrobca a predajca nenesú žiadnu zodpovednosť za nedodržanie príslušných ustanovení zákona, stavebných predpisov a bezpečnostných požiadaviek užívateľom výrobku, architektom, montérom alebo majiteľom objektu.